



GAS T ONE

Tightness test

1.0	IMPORTANT INFORMATION	05
1.1	Information about this manual	05
1.2	Danger levels and other symbols	05
2.0	SAFETY	06
2.1	Safety check	06
2.2	Intended use of the product	06
2.3	Improper use of the product	06
2.4	Precautions for the usage of the Li-Ion battery package	06
3.0	WORKING PRINCIPLE	07
3.1	General overview of the Analyzer	07
4.0	PRODUCT DESCRIPTION	08
4.1	Piezoelectric, temperature compensated pressure sensor	08
4.2	Bluetooth [®] connection	08
4.3	IR connection	08
4.4	QR Code generation	08
5.0	COMPONENTS DESCRIPTION	09
5.1	Instrument interface	09
6.0	TECHNICAL SPECIFICATIONS	11
6.1	Technical specifications	11
6.2	Measurement and accuracy ranges table	11
7.0	USING THE INSTRUMENT	12
7.1	Preliminary operations	12
7.2	Warning	12
7.3	Instrument power supply	12
7.3.1	Internal battery charge level	12
7.3.2	Use with external power pack	12
7.4	QR Code generation	13
7.5	Connection diagram	14
8.0	START SCREEN	15
8.1	Switch on the instrument	15
9.0	MEASUREMENTS	16
9.1	Measurements menu	16
9.2	Measurements menu→Measurements→Tightness test	17
9.3	Measurements menu→Measurements→Tightness test→New inst. (UNI 7129)	18
9.3.1	Tightness test configuration according to standard UNI 7129	21
9.3.2	Tightness test performance according to standard UNI 7129	24
9.4	Measurements menu→Measurements→Tightness test→Exist. inst. (UNI 11137)	25
9.4.1	Tightness test configuration according to standard UNI 11137	28
9.4.2	Tightness test performance according to standard UNI 11137	33
9.5	Measurements menu→Measurements→Tightness test →Result	34
9.6	Measurements menu→Measurements→Pressure	35
9.7	Measurements menu→Measurements→Temperature	36

10.0	INSTRUMENT PARAMETERS	37
10.1	Parameters menu	37
11.0	MEMORY	38
11.1	Menu→Memory	38
12.0	CONFIGURATION	40
12.1	Menu→Configuration	40
12.2	Menu→Configuration→Measurement unit	41
12.3	Menu→Configuration→Instrument	42
12.3.1	Menu→Configuration→Instrument→Display	43
12.3.2	Menu→Configuration→Instrument→Clock	44
12.3.3	Menu→Configuration→Instrument→Bluetooth	45
12.4	Menu→Configuration→Print	46
12.4.1	Menu→Configuration→Print→IR Printing	47
12.4.2	Menu→Configuration→Print→Pairing	48
12.5	Menu→Configuration→Language	49
12.6	Menu→Configuration→Restore	50
13.0	DIAGNOSTIC	51
13.1	Menu→Diagnostic	51
13.2	Menu→Diagnostic→Hardware	52
14.0	INFO SERVICE	53
14.1	Menu→Info service	53
15.0	MAINTENANCE	54
15.1	Routine maintenance	54
15.2	Programmed maintenance	54
15.3	Replacing the battery pack	54
15.4	Firmware update	55
16.0	TROUBLESHOOTING	56
16.1	Troubleshooting guide	56
17.0	SPARE PARTS AND SERVICING	57
17.1	Spare parts	57
17.2	Accessories	57
17.3	Service Centers	57
ANNEX A - Seitron Smart Analysis		58
ANNEX B - Declaration of Conformity		61
WARRANTY CERTIFICATE		63

SEITRON S.p.A. a socio unico - ALL RIGHTS RESERVED -

Total or partial reproduction of this document by any means (including photocopying or storage on any electronic medium) and transmittal of same to third parties in any manner, even electronically, is strictly prohibited unless explicitly authorized in writing by SEITRON S.p.A. a socio unico

1.0 IMPORTANT INFORMATION

1.1 Information about this manual

- This manual describes the operation, the features and the maintenance of the instrument in order to correctly perform the installation tightness test.
- Read this operation and maintenance manual before using the device. The user must be familiar with the manual and follow the instructions carefully.
- This use and maintenance manual is *subject to change due to technical improvements - the manufacturer assumes no responsibility for any mistakes or misprints.*

1.2 Danger levels and other symbols

	<p>The magnets on the back of the instrument can damage credit cards, hard drives, mechanical watches, pacemakers, defibrillators and other devices proven sensitive to magnetic fields. It is recommended to keep the instrument at a distance of at least 25cm away from these devices.</p>
--	---

Symbol	Meaning	Comments
--------	---------	----------



WARNING

Read information carefully and be ready to take appropriate safety procedures!

To prevent any danger from personnel or other goods. Not following the instructions of this manual may cause danger to people, the installation or the environment and may lead to liability loss.



Information on the display

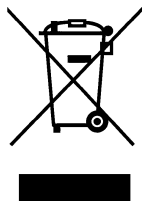

Disposal Indications

Dispose of the battery pack at the end of its working life only at the dedicated collecting bin.

This device must not be disposed as a urban litter. Dispose of the device according to national standards.



Keyboard with preformed keys with main control functions.

2.1 Safety check

- Use the product according to what is described in chapter “Intended purpose”.
- During the instrument operation, follow what stated in the current standards.
- Do not use the instrument if damaged on the outer cover, on the power supply plug or on the cables.
- Do not take measures on non-isolated components / voltage conductors.
- Keep the instrument away from solvents.
- For the maintenance of the instrument, strictly comply with what’s described in this manual at the “Maintenance” chapter.
- All the interventions not specified in this manual, may be performed exclusively by Seitron assistance centres. Otherwise, Seitron declines every responsibility about the normal operation of the instrument and on the validity of the several homologations.

2.2 Intended purpose

This chapter describes the areas of application for which this tightness test kit is intended.

The instrument allows to verify the gas distribution lines according to what is stated on the UNI7129 and UNI11137 standards and for the temperature and pressure measurement.

2.3 Improper use of the product

GAS T ONE should not be used:

- As safety alarm instrument
- In classified zones with explosion risk (ATEX or equivalent)

2.4 Precautions for the usage of the Li-Ion battery package

Pay attention while handling the battery package inside the instrument; a wrong or improper usage may lead to heavy physical injuries and/or damages:

- Do not create a short circuit: make sure that the terminals are not in contact with metal or other conductive materials during transportation or storage.
- Do not apply with inverted polarities.
- Do not make the batteries come in contact with liquid substances.
- Do not burn the batteries nor expose to temperature higher than 140 °F (60°C).
- Do not try to disassemble the battery.
- Do not hit or pierce the batteries. Improper use can cause damages and internal short circuits not always externally visible. If the battery package has fallen or has been hit with an hard surface, regardless the external shell condition:
 - Stop operation;
 - Dispose of the battery in compliance with the disposal instructions;
- Do not use batteries with leaks or damages.
- Charge the batteries only inside the instrument.
- If a malfunction occurs or if over heating signs occur, immediately remove the battery package from the instrument. Warning: the battery may be hot.

3.1 General overview of the instrument

The instrument is featured with:

- Internal pressure sensor.
- Intuitive user interface; the instrument could be used even without the instruction manual support.
- Wide and bright graphic display.
- Rechargeable 'Li-Ion' battery.

Main functions:

- Gas distribution installations testing according to standards UNI7129 and UNI11137.
- Memory capable of storing up to 5 full tests.
- It is possible to print on ticket the performed measurements, with Bluetooth® and/or IR printer.
- Temperature measurement with TcK probe.

Measured values:

- System pressure, combustion chamber pressure and pressure switch verification, using the measuring range up to 200hPa.
- Pressure measurement.
- Gas distribution line pressure measurement

Calibration certificate

The instrument comes with a calibration certificate made according to EN17025 standard requirements.

4.1 Piezoelectric, temperature compensated pressure sensor

The instrument is internally provided with a piezo-resistive differential pressure sensor which can be used for the tightness test of the installation and the pressure measurement of the latter.

The measurement range is -100,00 hPa ... +200,00 hPa.

Any potential drift of the sensor are nulled thanks to the autozeroing system.



WARNING

ANY PRESSURE APPLIED TO THE SENSOR GREATER THAN ± 300 hPa MAY CAUSE A PERMANENT DEFORMATION OF THE MEMBRANE, THUS DAMAGING IRREVERSIBLY THE SENSOR ITSELF.

4.2 Bluetooth® connection

The instrument is provided with a **Bluetooth®** module, which allows the communication with the remote **Bluetooth®** printer.

The maximum transmission range in open field is 100 meters (Class 1 Bluetooth® module), provided that also the communication companion is equipped with a Class1 Bluetooth® interface.

This solution allows great freedom of movement for the operator who is no longer bound directly to the instrument for acquisition and analysis, with significant advantages for many applications.

4.3 IR connection

This tightness test kit is internally equipped with an infrared light interface which uses the HP-IR protocol, which allows the communication with a remote IR printer.

4.4 Software and available applications

Seitron Smart Analysis

This APP, allows to scan the QR code generated by the instrument, aiming to download the data of the performed analyses and/or measures.

5.1 Instrument interface

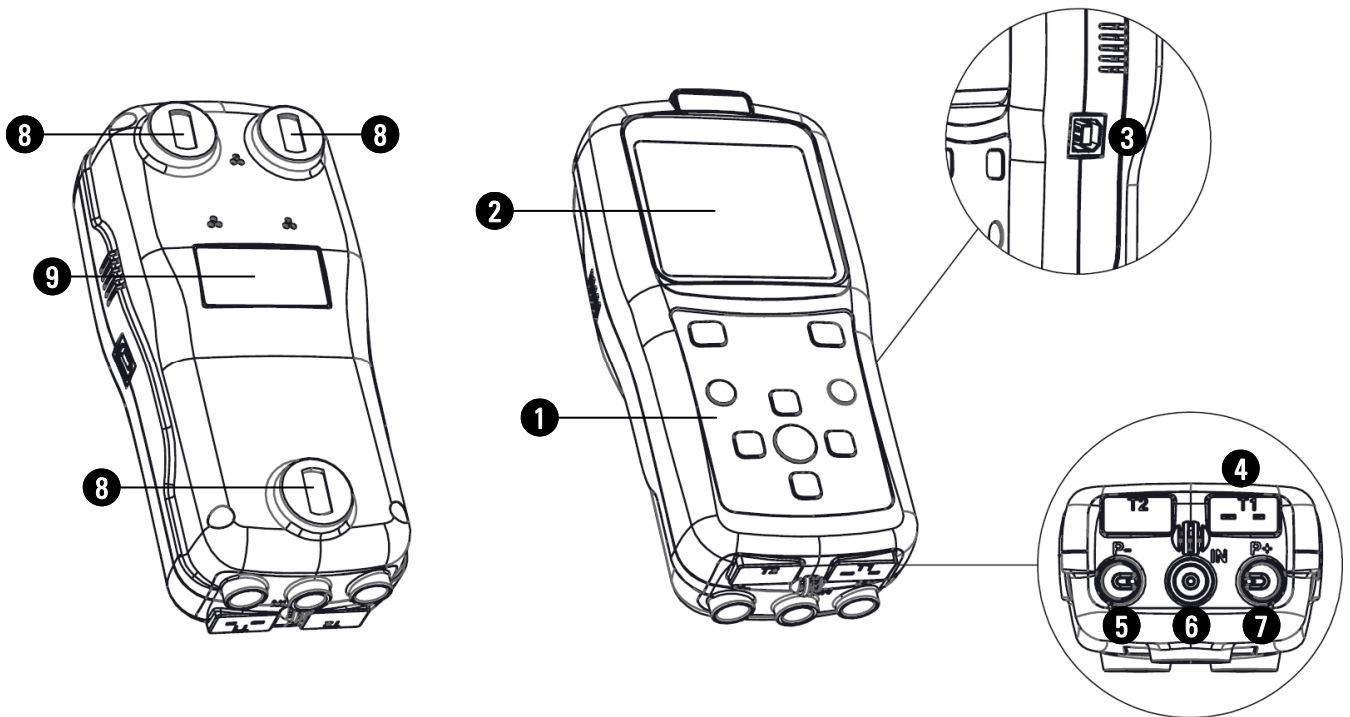

DESCRIPTION:

1 Polyester keyboard with preformed keys and main command functions:

KEYS	FUNCTION
	Activates the context keys shown on the display.
	<ul style="list-style-type: none"> - Turns on and off the instrument. - If pressed briefly, accesses the instrument menu. - If pressed for at least 2 seconds, turns off the instrument.
	Exits the current screen.
	<ul style="list-style-type: none"> - Enters the setting mode of the selected data. - Confirms settings.
	Select and/or Modify.

2 Display

CAUTION:

If the instrument is exposed to extremely high or extremely low temperatures, the quality of the display may be temporarily impaired. Display appearance may be improved by acting on the contrast key.

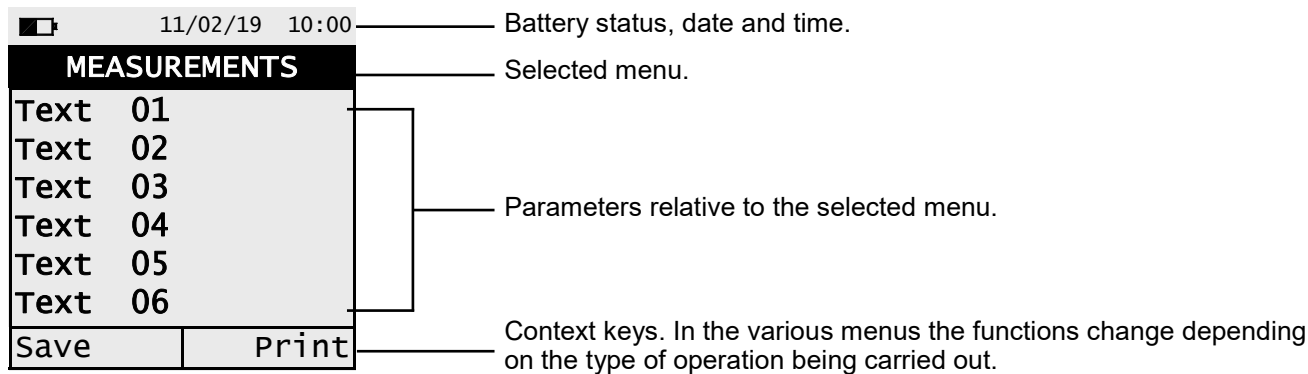

3 B-Type USB connector

Connection port to plug the device to a personal computer or to the battery charger.

4 'T1' Connector. Type K thermocouple ingress

5 'P-' pneumatic connector

Negative input (P-) to be used for the pressure measurement.

6 Not used

7 'P+' pneumatic connector

Positive input (P+): used for the pressure measurements values.

8 Magnets

9 Instrument data label

6.0 TECHNICAL SPECIFICATIONS

6.1 Technical specifications

Power supply:	Li-Ion battery pack with internal protection circuit.
Average life of the battery pack:	500 empty / full charge cycles.
Battery charger:	External 5Vdc 2A battery charger with female A-type USB connector + connection to the device with the same serial communication cable supplied.
Charging time:	5 hours to charge from 0% to 90% (6 hours for 100%). The device can also be charged by connecting it to the PC, the device must be turned off, the charging time depends on the output current from the PC and may be more than 12 hours.
Instrument operability time:	20 hours of non-stop operation.
<hr/>	
Display:	Graphic white LED backlit White / Black, 128 x 128 pixel
<hr/>	
<u>Connectivity:</u>	
Communication port:	USB connector type B.
Bluetooth®:	Class 1. Communication distance <100 meters (in open field)
Infrared interface:	For external printer (optional) using protocol HP-IR.
<hr/>	
Self-diagnosis:	Checks all functions and internal sensors and reports any abnormal operation.
<hr/>	
Internal data memory:	5 complete tests and measurements.
<hr/>	
Operating temperature range:	-5°C .. +45°C
Storage temperature range:	-20°C .. +50°C
Humidity limit:	20% .. 80% RH
Protection rating:	IP42
Air pressure:	Atmospheric
Outer dimensions:	Device: 7 x 6 x 17 cm (L x A x P) Case: 40 x 29 x 12 cm (L x A x P)
Weight:	Device: ~ 0,35 Kg

6.2 Measurement and Accuracy Ranges

MEASUREMENT	SENSOR	RANGE	RESOLUTION	ACCURACY	RESPONSE TIME T90
Temperature T1	TcK Sensor	-20.0 .. 800.0 °C	0.1 °C	±1 °C ±1% measured value	-20 .. 100 °C 101 .. 800 °C <30 sec.
Pressure (differential)	Piezoelectric sensor	-100.00 .. 200.00 hPa	0.01 hPa	±1% measured value ±0.02 hPa ±1% measured value	-100.00 .. -2.01 hPa -2.00 .. +2.00 hPa +2.01 .. +200.00 hPa <10 sec

7.0 USING THE INSTRUMENT

7.1 Preliminary operations

Remove the instrument from its packing and check it for damage. Make sure that the content corresponds to the ordered items. If signs of tampering or damage are noticed, notify that to the SEITRON service center or agent immediately and keep the original packing.

A label applied on the back of the instrument contains the serial number.

This serial number should always be kept in mind when requesting technical assistance, spare parts or clarification on the product or its use.

Seitron maintains an updated database for each and every instrument.

Before using the instrument for the first time, we recommend you charge the batteries completely.

7.2 WARNING

Use the instrument with an ambient temperature between -5 and +45°C.

7.3 Instrument power supply

The instrument contains an high-capacity Li-Ion rechargeable battery.

If the battery is too low to perform the measures, by using the power plug (provided) it is possible to continue to work: the power plug charges the battery and keeps the instruments running.

The battery charging cycle takes up to 6 hours for a complete charge and finishes automatically.

WARNING: If the instrument is not going to be used for a long time we suggest recharging it at least once every 4 months.

7.3.1 Internal battery charge level

The display constantly shows the internal battery charge level shown with the symbol in the upper left corner of the display.

SYMBOL	BATTERY CHARGE LEVEL
	100%
	80%
	60%
	40%
	20% It's advisable to recharge the battery.
	Dead battery Recharge the battery - The instrument may not function correctly.



THE INSTRUMENT IS SHIPPED WITH THE 30% OF BATTERY LIFE SO IT IS ADVISABLE TO CHARGE IT COMPLETELY BEFORE USE, TAKING 3 HOURS.

IT IS ADVISABLE TO CHARGE THE BATTERY AT AN AMBIENT TEMPERATURE RANGING BETWEEN 50°F AND 86°F (10°C AND 30°C).

7.3.2 Use with power plug

The instrument can work with the batteries fully discharged by connecting the provided power plug.



**THE POWER SUPPLY/BATTERY CHARGER IS A SWITCHING TYPE ONE.
THE APPLICABLE INPUT VOLTAGE RANGES BETWEEN 90Vac AND 264Vac.
INPUT FREQUENCY: 50-60Hz.**

THE LOW VOLTAGE OUTPUT IS 5 VOLT WITH AN OUTPUT CURRENT GREATER THAN 1.5A.

LOW VOLTAGE POWER CONNECTOR: A-TYPE USB CONNECTOR + CONNECTION CABLE WITH B-TYPE PLUG.

7.4 QR Code generation

The instrument offers the possibility to generate and display a QR Code.

With this code it is possible to download the data of the performed measures by activating the interactive function "Print" shown on the display when the tightness test is over or during the pressure and temperature measurement and on the memory menu. To correctly display and store the measurement and/or tightness tests data it is necessary to install on your device the App "SEITRON SMART ANALYSIS" downloadable from the AppStore.

Minimum requirements to install the "SEITRON SMART ANALYSIS" App

Operative systems: Android from version 4.1
 Apple (iOS)



THE INSTRUMENT WILL GENERATE THE QR CODE ONLY IF ON THE DISPLAY THE INTERACTIVE FUNCTION "PRINT" IS SHOWN, PRIOR CORRECT SETTING OF THE PARAMETER "CONFIGURATION→PRINT".

7.5 Connection diagram

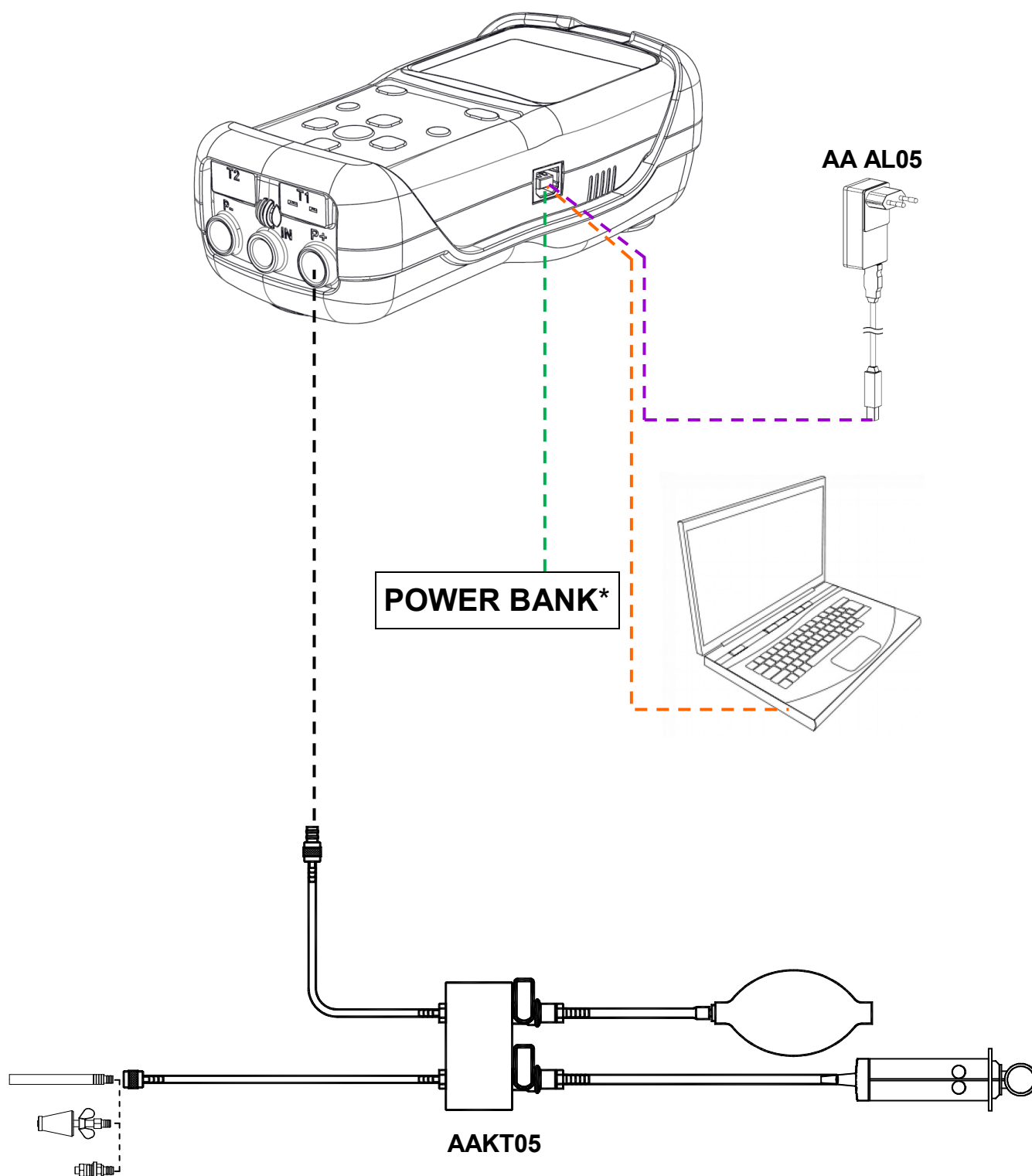

* = Only for battery charge.

8.0 START SCREEN

8.1 Switch on the instrument

On the first screen, the instrument shows the information about the customization, serial number and firmware number. Then, the instrument shows the measures screen, from which it is possible to perform the installation tightness test, pressure measurement or the temperature measurement; by briefly pressing the '☰' button it is possible to access the configuration menu.

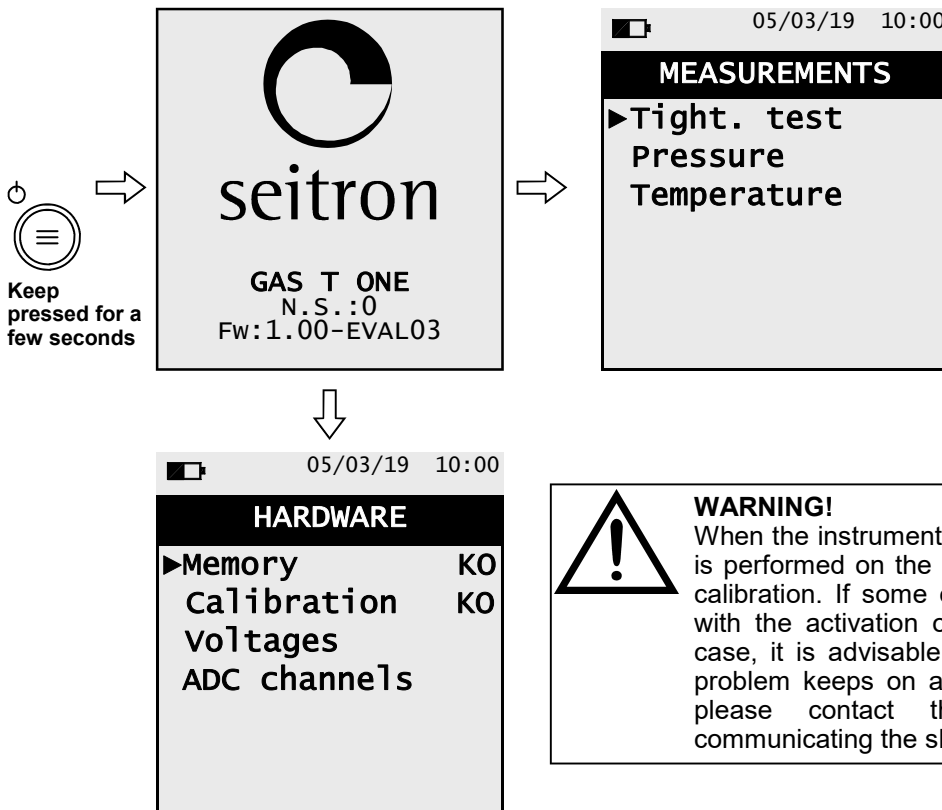

9.0 MEASUREMENTS

9.1 Menu→Measurements

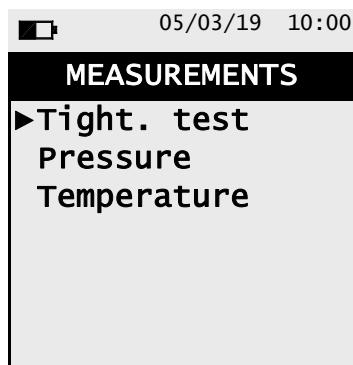

KEY	FUNCTION
	Enters in the selected measure.
	Selects the available parameters.
	Returns to the previous screen.

PARAMETER	DESCRIPTION
Tightness test	The instrument is able to perform the tightness test on installations using combustible gas according to UNI 7129-1: 2015 and UNI 11137: 2012 standards, respectively related to new or restored installations and existing installations. The results of the tightness tests, which execution modes are described in the following, can be printed at the end of the test. The last tightness test is kept in the instrument RAM and visible on the screen "Results" as long as the instrument is not turned off. SEE CHAPTER 9.2
Pressure	Through the use of the external flexible pipe made in RAUCLAIR (supplied) it is possible to measure a pressure value within the range stated in the technical features (connect the pipe to P+ input). SEE CHAPTER 9.6
Temperature	The external temperature can be measured with a special K-type thermocouple probe to be connected to the T1 input. SEE CHAPTER 9.7

9.2 Menu→Measurements→Tightness test

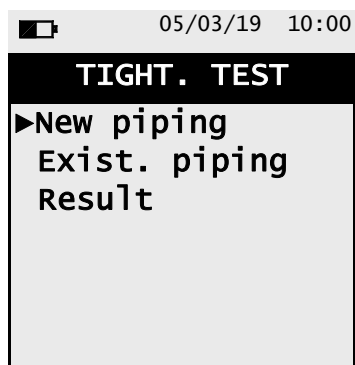

KEY	DESCRIPTION
	Enters the selected parameter
	Selects the available parameters
	Goes back to the previous screen

PARAMETER	DESCRIPTION
New piping	Through this menu it is possible to perform the tightness test, according to standard UNI 7129-1: 2015, on new or renewed installations or after a repairing operation. SEE CHAPTER 9.3
Exist. piping	Through this menu it is possible to perform the tightness test, according to standard UNI 11137: 2012, on existing installations. SEE CHAPTER 9.4
Result	Through this menu it is possible to recall the last test performed until the instrument is switched off. SEE CHAPTER 9.5

9.2.1 Tightness test kit connection to the instrument

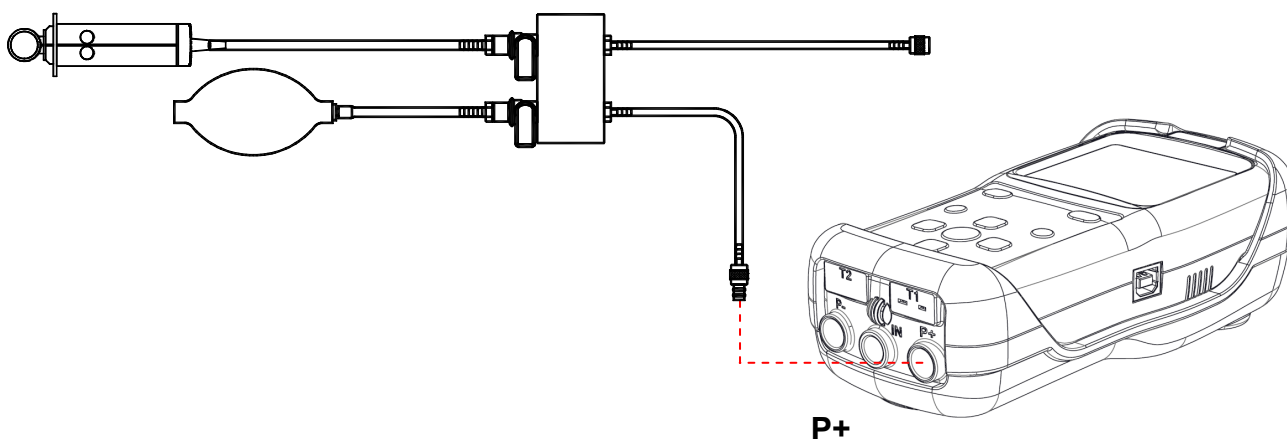

9.3 Menu→Measurements→Tightness test→New inst. (UNI 7129)

05/03/19 10:00

UNI 7129

▶Stabil.	15 min	▶	Duration of the stabilization phase that can be set between 15 .. 99 minutes.
Volume	manual	▶	Volume input mode can be set as "Manual" and "<100 l".
V:	20.0 l	▶	System volume, which can be set if known.
Measure V		▶	Measures the system volume.
Calculate V		▶	Calculates the volume on the basis of the features of the piping

Start

KEY	DESCRIPTION
	Activate the interactive operations shown on the display.
	Modifies the selected parameter.
	Selects the available parameters. When modifying the system volume, sets the desired value.
	Return to the previous screen.

INTERACTIVE OPERATION	DESCRIPTION
Start	Go to the next stage of the tightness test.
Restart	Repeats the phase just concluded.
Zero	Performs the zero procedure.
V+	Adds the volume of the inserted pipe section.
V-	Subtracts the volume of the inserted pipe section.
Test	Stops the stabilization phase and starts the tightness test phase.
Repeat	Repeats the tightness test phase.
Print	Print the test result on the ticket and/or generates the QR code according to the "Print" menu setting.

Details of the test:

The standard UNI 7129-1: 2015 can be adopted for testing new piping systems or reconditioned ones. This test requires to charge the piping up to a pressure between 100 hPa and 150 hPa, then wait for a stabilization which must last at least 15 minutes and required in order for the thermal effects caused by the test gas compression to fade out, and finally to test the piping tightness by analysing the decay of pressure over time.

The maximum pressure decay measured, expressed as a function of the piping volume, must be smaller than the values shown in the following table:

Internal plant volume (liters)	Waiting time (minutes)	Maximum pressure drop (hPa)
$V \leq 100$	5	0,5
$100 < V \leq 250$	5	0,2
$250 < V \leq 500$	5	0,1

Table 1.

The GAS T ONE allows the user to customize the stabilization phase through the following parameter:

WAIT TIME: it is the stabilization time and can be set by the user from 15 to 99 minutes. Please note that UNI 7129-1: 2015 standard requires a stabilization time of at least 15 minutes, anyway there is the possibility to skip stabilization by pressing '  ' button.

VOLUME SETUP: An accurate tightness test performed according to the UNI 7129-1: 2015 standard requires to know the piping volume.

Because this data is often unavailable the GAS T ONE splits the test from the beginning into two different paths:

<100l: valid for systems with a volume under 100 dm³ (litres), the most frequent, where it is not required to enter the value of the volume since it is assumed that the system has a volume of 100 dm³.

Manuale: in this case it is necessary to set the volume of the system by entering the numeric value if known, or by calculating the amount as the sum of the contributions of the different sections of piping or, even, by assessing the measurement with a simple procedure that requires the injection into the system of a known amount of gas using a syringe.

If you use volume calculation, for each section of piping it is necessary to set the material, the nominal diameter and the length of the same. The GAS T ONE calculates the volume of the section ("partial volume") and it adds it up, activating the context key ' **V+** ' (add up piping), to the calculation of the volume of the system. To correct any errors of to modify the current calculation, the subtraction operation is also allowed by activating the context key ' **V-** ' (subtract piping).

When the 'Volume measurement' option is selected instead, the procedure, described also in the flow charts of the tightness test according to UNI 7129-1: 2015, is described in the following steps:

- Close both valves of the piping kit supplied for the test.
- Connect the syringe to the kit opposite to the pump.
- Press the key relative to the context key ' **Start** '.
- Open the valve on the side where the syringe is connected, take exactly 100 ml (100 cc) of the gas present in the system.
- Wait for the stabilisation of the pressure of the system. After a few seconds, the device displays the measured volume. The suggested value can be accepted by pressing the key '  ' and then modified by selecting, in "UNI 7129 Configuration" the line "volume".
It is also possible to repeat the measurement of the volume by pressing the key relative to the interactive function ' Restart '.

Once the stabilization parameter has been set the user can proceed with the tightness test. By pressing the key relative to the context key ' **Start** ', first the test pressure is indicated, as required by law, then you can access a screen which displays the pressure reading of the inputs of the device.

After zeroing the device and putting the system under a pressure of at least 100 hPa, it is possible to start the tightness test by pressing the key relative to the context key ' **Start** ', which starts the stabilisation phase. In the stabilisation screen, the following values are displayed:

- P ist:** Actual pressure measured by the instrument, in the selected measurement unit.
- dP 1m:** Pressure variation in the last minute, updated every 10 seconds. This value gives a rough indication about the stabilization level reached in the piping system.
- Wait time:** Remaining time before the stabilization phase ends.

Once the stabilization phase is terminated the tightness test is started. This test is performed by observing how the pressure decays in time during a fixed 5 minutes interval, as stated in the applied standard.

During the tightness test phase the following values are displayed:

- P ini:** Pressure measured at the beginning of the test.
- P ist:** Pressure actually measured by the instrument.
- dP:** Pressure variation with respect to the initial value. In case the actual pressure is lower than the initial value (pressure is decreasing) this value has a negative sign.
- Wait time:** Remaining time of the tightness test.

After the tightness test is over, the results are displayed; the data are displayed as follows:

- P ini:** Pressure measured at the beginning of the test.
- P ist:** Pressure measured by the device.
- dP:** Pressure variation between the last instant and the first instant of the test. If the pressure decreased, it presents a negative value.
- Result:** Reports the test result:
 - tight** when the pressure is within the limit of table 1.
 - leak** when the pressure is outside the limit of table 1.Positive pressure changes are symptom of a temperature change meanwhile the test is performed. Should this happen it is advisable to repeat the entire test.
operator if the Δ pressure is higher than +3 hPa it is operator's discretion whether repeat the test or not because the pressure and/or temperature conditions may have changed during the test.

9.3.1 TIGHTNESS TEST CONFIGURATION ACCORDING TO STANDARD UNI 7129-1: 2015

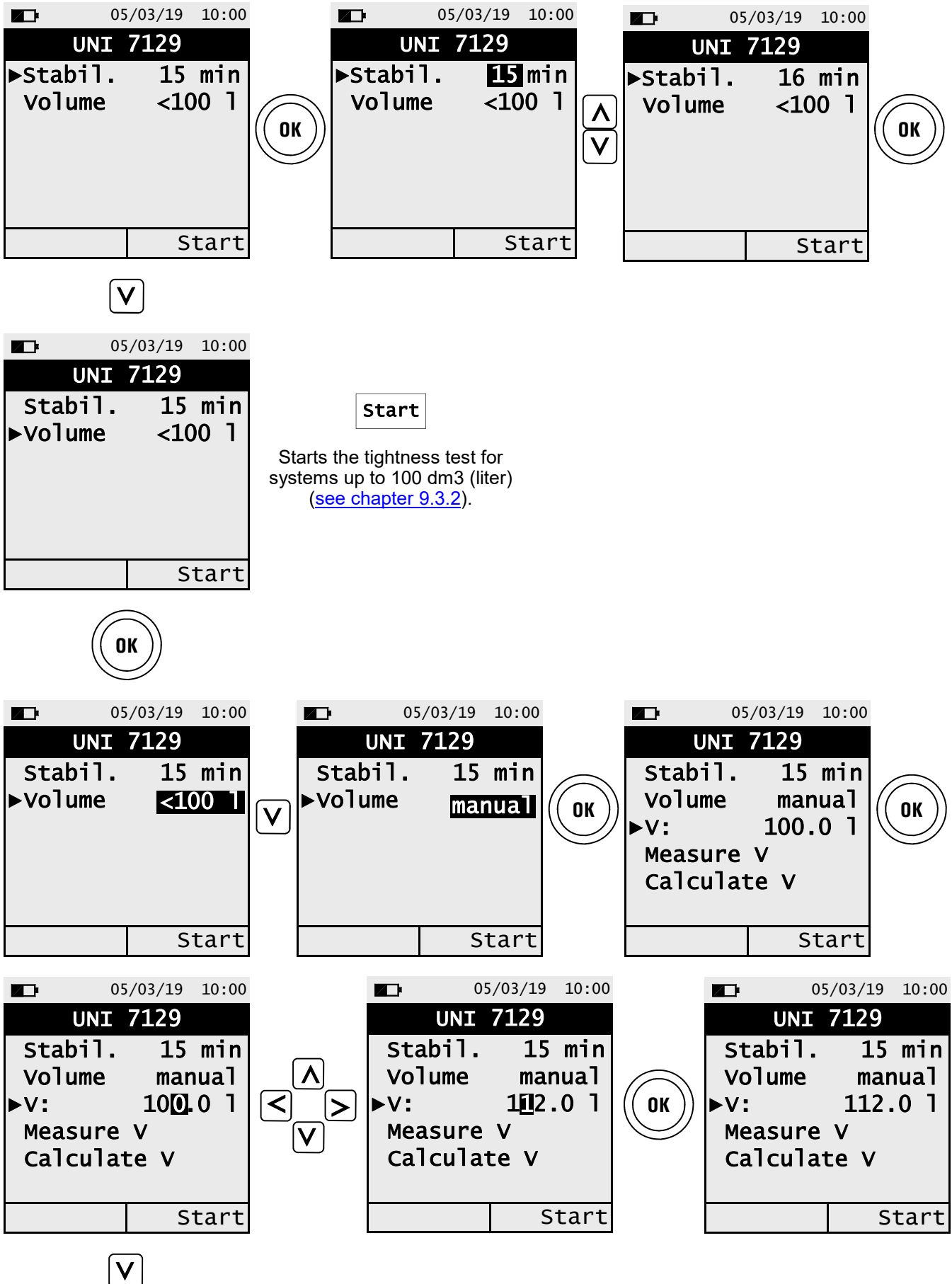

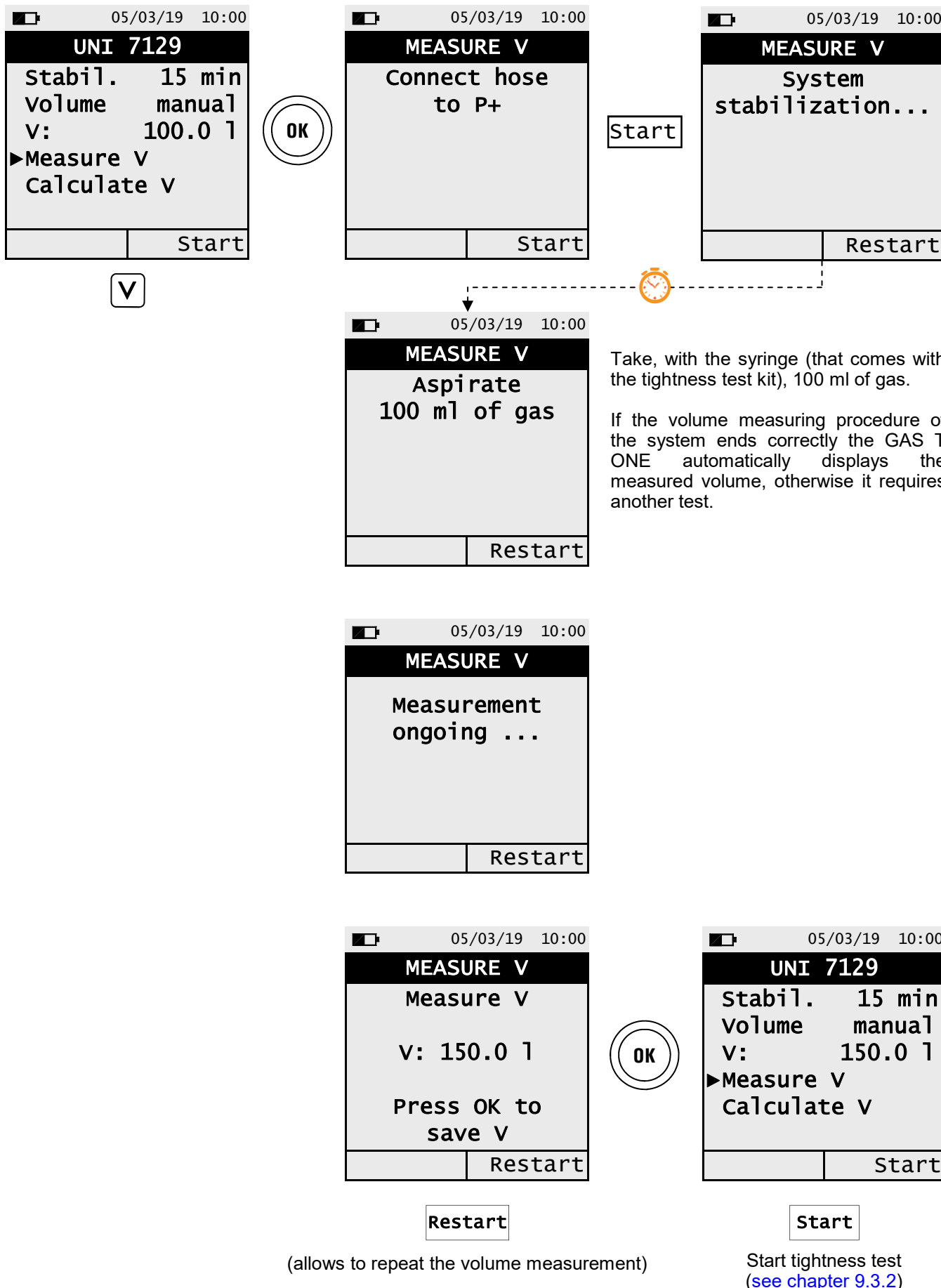

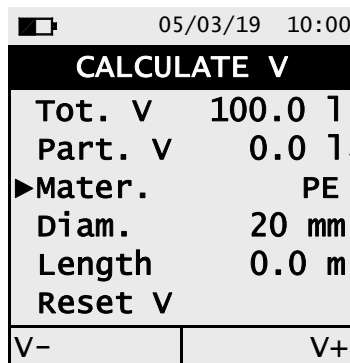
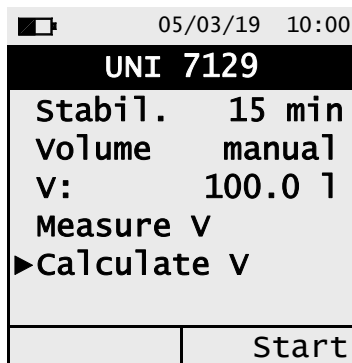

- ▶ Total acquired volume
- ▶ Volume of the set pipe section
- ▶ Set the piping section material
- ▶ Set the nominal diameter of the piping section
- ▶ Set the piping section length
- ▶ Reset the previously acquired volume.

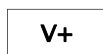
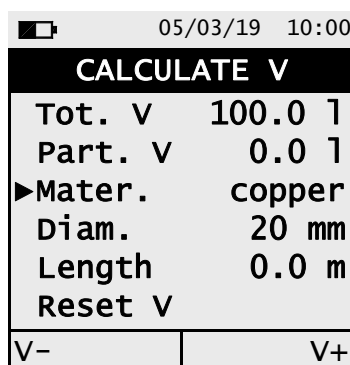

Adds the volume of the set piping section.

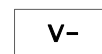

Subtracts the volume of the set piping section.

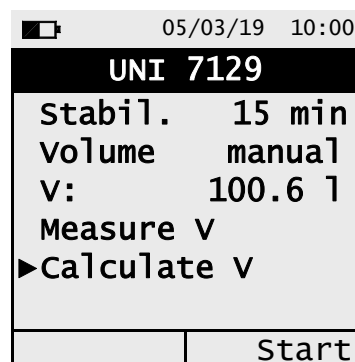
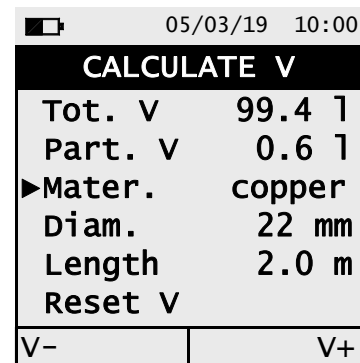
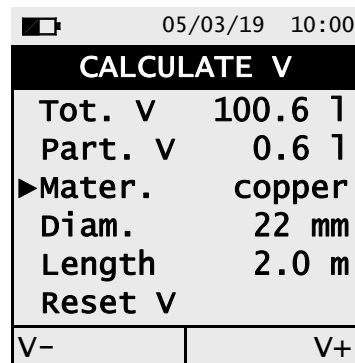

Start tightness test
(see [chapter 9.3.2](#))

9.3.2 PERFORMING TIGHTNESS TEST ACCORDING TO STANDARD UNI 7129-1: 2015

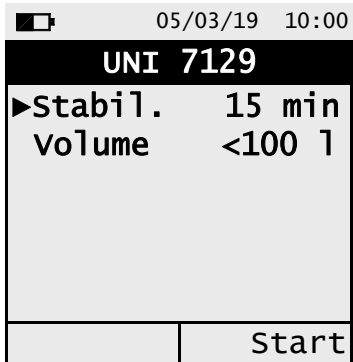

Start

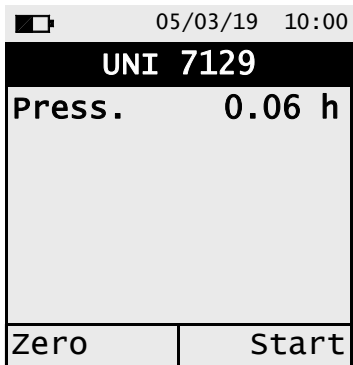
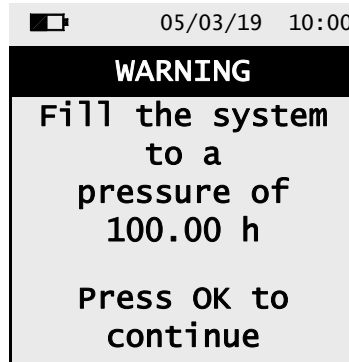

Zero



Wait for the autozero to be finished, then apply pressure to the system and press "Start"

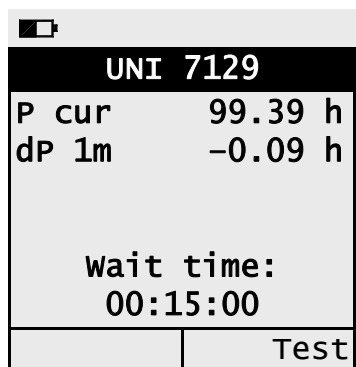

System pressure

Pressure change in the last minute.

Wait time to finish the stabilization phase.

Press "TEST" to interrupt the stabilization phase.

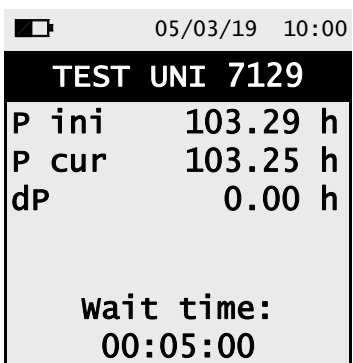

Tightness test result:
Tight or leak

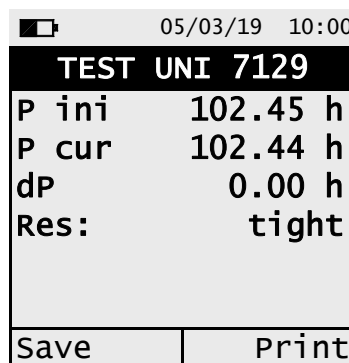

9.4 Measurements menu → Measurements → Tightness test → Exist. inst. (UNI 11137)

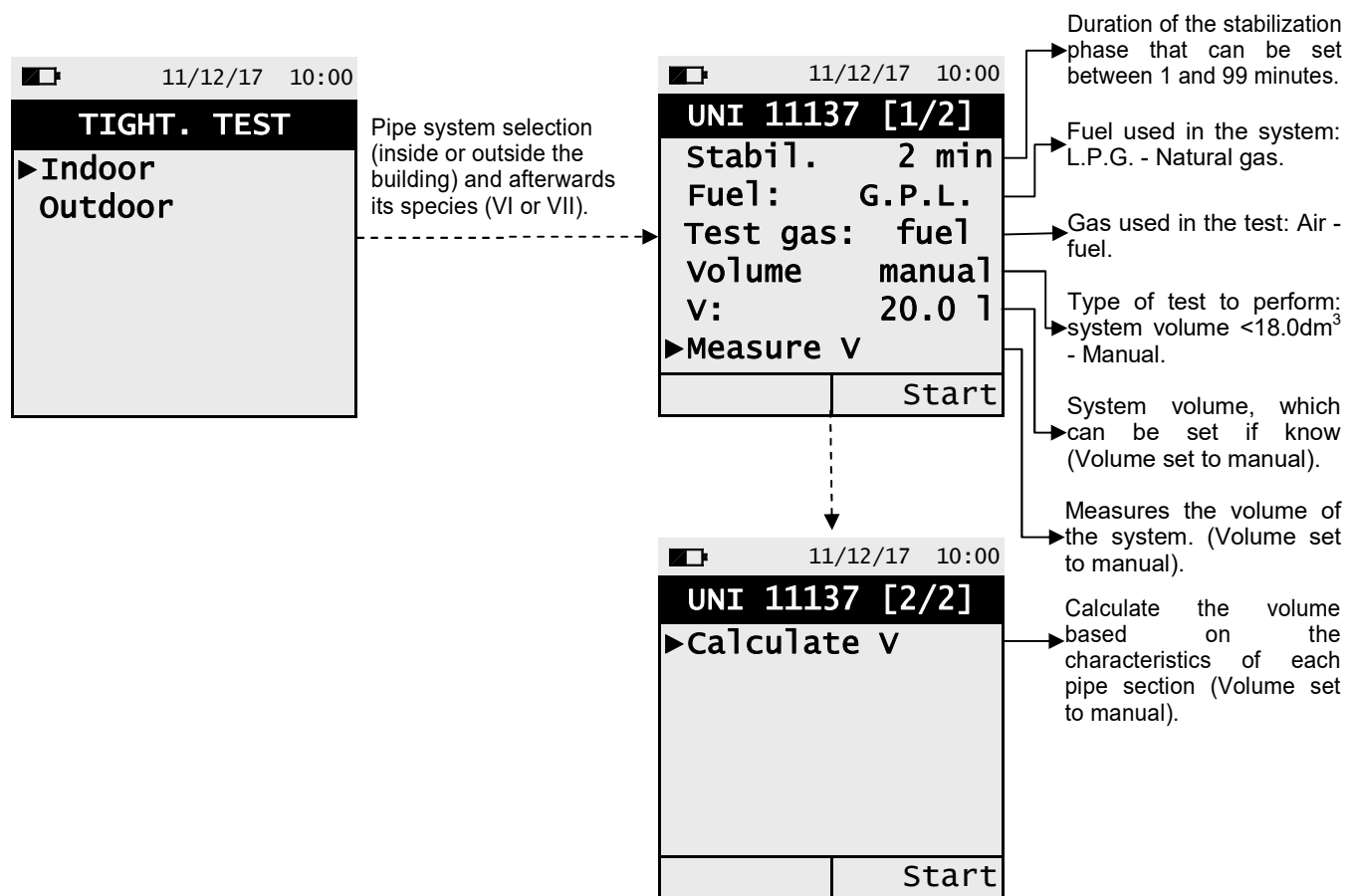

KEY	DESCRIPTION
	Activate the interactive operations shown on the display.
	Modifies the selected parameter, select the type of pipe system or select the type of plant.
	Selects the available parameters. When modifying the system volume, sets the desired value.
	Return to the previous screen.

INTERACTIVE OPERATION	DESCRIPTION
Start	Go to the next stage of the tightness test.
Restart	Repeats the phase just concluded.
Zero	Performs the zero procedure.
V+	Adds the volume of the inserted pipe section.
V-	Subtracts the volume of the inserted pipe section.
Test	Stops the stabilization phase and starts the tightness test phase.
Repeat	Repeats the tightness test phase.
Print	Print the test result on the ticket and/or generates the QR code according to the "Print" menu setting.

Details of the test:

The UNI 11137: 2019 standard is applied to the 6th and 7th species operating systems, defining the leakage limits depending on the fact that the leak is located inside or outside the building. This test requires to charge the piping up to the test pressure, then wait for an unspecified stabilization time until the thermal effects caused by the test gas compression are nulled, and then calculate the amount of the possible leakage from the measure of the pressure decays in 1 minute time. If the preliminary test is performed using LPG test gas and combustible test gas, the evaluation of the leakage entity, performed through the pressure decay measurement, occurs within 2 minutes and 30 seconds.

WARNING

The system volume measurement is reliable up to a maximum volume of 100 dm³.

The test pressure should be as close as possible as the reference conditions following explained.

REFERENCE CONDITIONS: According to the combustible gas to be used in the piping, the tightness test must be performed in one of the following reference conditions:

Methane:	Reference pressure for test with supply gas	2200 Pa
	Test pressure with air	2200 Pa
L.P.G.:	Reference pressure for test with supply gas	3000 Pa.
	Test pressure with air	3000 Pa.

GAS T ONE allows the user to customize the stabilization phase:

STABILISATION: the stabilization phase duration can be set in the 1 .. 99 minutes range. As the UNI 11137: 2019 standard does not prescribe any stabilization duration, the factory setting for this value is borrowed from the UNI 7129-1: 2015 standard, which requires a minimum stabilization time of 15 minutes.

The waiting time can however be interrupted by activating the context key '  ' even if the interval is not over.

The tightness test performed according to the UNI 11137: 2019 standard requires the input of some data regarding the piping system and the test conditions, as described in the following.

SYSTEM: Performing the tightness test according to UNI 11137: 2019 requires to set the system part which it is intended to verify: Internal or External to the building.

COMBUSTIBLE GAS: consider that the amount of the leakage is strictly related to the nature of the gas under pressure. When the tightness of a piping has to be evaluated it is mandatory to specify the family to which the gas belongs: Methane or L.P.G.

TEST GAS: again the amount of the leakage is related to the nature of the gas under pressure, therefore it is mandatory to specify the type of the gas used: Natural Gas, L.P.G. or air. Please note that the gas used for the test could also be different from the gas to be used in the plant and could even be a not flammable gas.

TYPE OF TEST: An accurate tightness test performed according to the UNI 11137: 2019 standard requires to know the piping volume.

Because this data is often unavailable, GAS T ONE splits the test from the beginning into two different paths:

Preliminary: valid for systems with a volume under 18 dm³ (liters), the most frequent, where it is not required to enter the value of the volume since it is assumed that the system has a volume of 18 dm³.

Complete: in this case it is necessary to set the volume of the system by entering the numeric value if known, or by calculating the amount as the sum of the contributions of the different sections of piping or, even, by assessing the measurement with a simple procedure that requires the injection into the system of a known amount of gas using a syringe.

If you use volume calculation, for each section of piping it is necessary to set the material, the nominal diameter and the length of the same. GAS T ONE calculates the volume of the section ("partial volume") and it adds it up, activating the context key ' **V+** ' (sum piping), to the calculation of the volume of the system. To correct any errors of to modify the current calculation, the subtraction operation is also allowed by activating the context key ' **V-** ' (subtract piping). When the 'Volume measurement' option is selected instead, the procedure, described also in the flow charts of the tightness test according to UNI 11137: 2019, is described in the following steps:

- Close both valves of the piping kit supplied for the test.
- Connect the syringe to the kit opposite to the pump.
- Press the key relative to the context key ' **Start** '.
- Open the valve on the side where the syringe is connected, take exactly 100 ml (100 cc) of the gas present in the system.
- Wait for the stabilization of the pressure of the system. After a few seconds, the device displays the measured volume. The suggested value can be accepted by pressing the key '  ' and then modified by selecting, in "UNI 11137 Configuration" the line "volume".

It is also possible to repeat the measurement of the volume by pressing the key relative to the interactive function ' **Repeat** '.

Table volumes:

Examples relating to the various lengths of indoor systems, capacity approximately corresponding to 18dm³, depending on the material and the diameter of the fuel gas adduction pipe.

Steel		Copper / Multilayer/ Polyethylene	
Diameter	length (m)	Internal diameter (mm)	length (m)
1/2"	82 (68)	10	228 (190)
3/4"	49 (40)	12	160 (133)
1"	28 (23)	14	116 (97)
1 1/4"	17 (14)	16	90 (75)
		19	64 (53)
		25	37 (31)
		26	34 (28)
		34	20 (17)

Note: When the measurement group can not be excluded from the test, the indicative length of the plant is given in brackets.

Once the stabilization mode has been defined and the required data has been entered, you can proceed with the tightness test. By pressing the key relative to the context key ' **Start** ', first the test pressure is indicated, as required by law, then you can access a screen which displays the pressure reading of the inputs of the device. After zeroing the device and putting the system under a pressure of at least 100 hPa, it is possible to start the tightness test by pressing the key relative to the context key ' **Start** ', which starts the stabilization phase. In the stabilization screen, the following values are displayed:

- P cur:** Actual pressure measured by the instrument, in the selected measurement unit.
- dP 1m:** Pressure variation in the last minute, updated every 10 seconds. This value gives a rough indication about the stabilization level reached in the piping system.
- Waiting time:** Remaining time before the stabilization phase ends.

When the stabilization phase is over, the system tightness test evaluation is performed by measuring the pressure decay in a non-editable time interval of 1 minute for each setting, except when the preliminary test with LPG and combustible gas is performed; in this case the time interval is 2 minutes and 30 seconds, as required by the standard.

During the tightness test phase the following values are displayed:

- P cur:** Pressure measured at the beginning of the test
- P ist:** Pressure actually measured by the instrument
- dP:** Pressure variation with respect to the initial value. In case the actual pressure is lower than the initial value (pressure is decreasing) this value has a negative sign.
- Waiting time:** Remaining time before the Test phase ends.

Once the test has finished, the results are displayed; the data displayed is as follows:

- P ini:** Pressure measured at the beginning of the test
- P fin:** Pressure measured by the device.
- dP:** Pressure variation between the last instant and the first instant of the test. If the pressure decreased, it presents a negative value.
- Qtest:** Is the calculated leakage measured in dm³/h according to the conditions under which the test has been performed, i.e. the gas used for the test as well as the final pressure measured during the test.
- Qref:** is the calculated leakage measured in dm³/h according to the reference conditions described in the standard, it is related to the gas to be used in the piping as well as to the reference pressure.
- Res:** is the result of the tightness test.

Compliant (piping suitable for operation):
the plant is authorized to operate without restrictions or intervention.

Compl. 30 DD (piping temporarily suitable for operation):
the system is authorized to operate only for the time needed for the maintenance of the pipe in order to fix the leakage problem, and in any case for no more than 30 days after the testing day. Once the fixing has been completed the piping must be tested again for its tightness according to the UNI 7129 standard.

Non compliant (not suitable for operation):

In this situation the measured leakage is such that the piping is not suitable for operation and must immediately be placed out of order. Once the leakage problem has been fixed the piping must be tested again for its tightness according to the UNI 7129 standard.

Operator

If the Δ pressure is higher than +3 hPa it is the operator's choice if they repeat the test or not because the pressure and/or temperature conditions might have changed during the test.

On the table below are shown the leakage limits according to standard UNI 11137: 2019:

RESULT	LEAKAGE POSITION	METHANE LIMIT	LPG LIMIT
Compliant	Inside and outside of the building	Up to 1 dm ³ /h	Up to 0.4 dm ³ /h
Compliant 30 days	Inside the building	1 dm ³ /h < Qref ≤ 5 dm ³ /h	0,4 dm ³ /h < Qref ≤ 2 dm ³ /h
	Outside the building	1 dm ³ /h < Qref ≤ 10 dm ³ /h	0,4 dm ³ /h < Qref ≤ 4 dm ³ /h
Non compliant	Inside the building	≥ 5 dm ³ /h	≥ 2 dm ³ /h
	Outside the building	≥ 10 dm ³ /h	≥ 4 dm ³ /h

9.4.1 TIGHTNESS TEST CONFIGURATION ACCORDING TO STANDARD UNI 11137

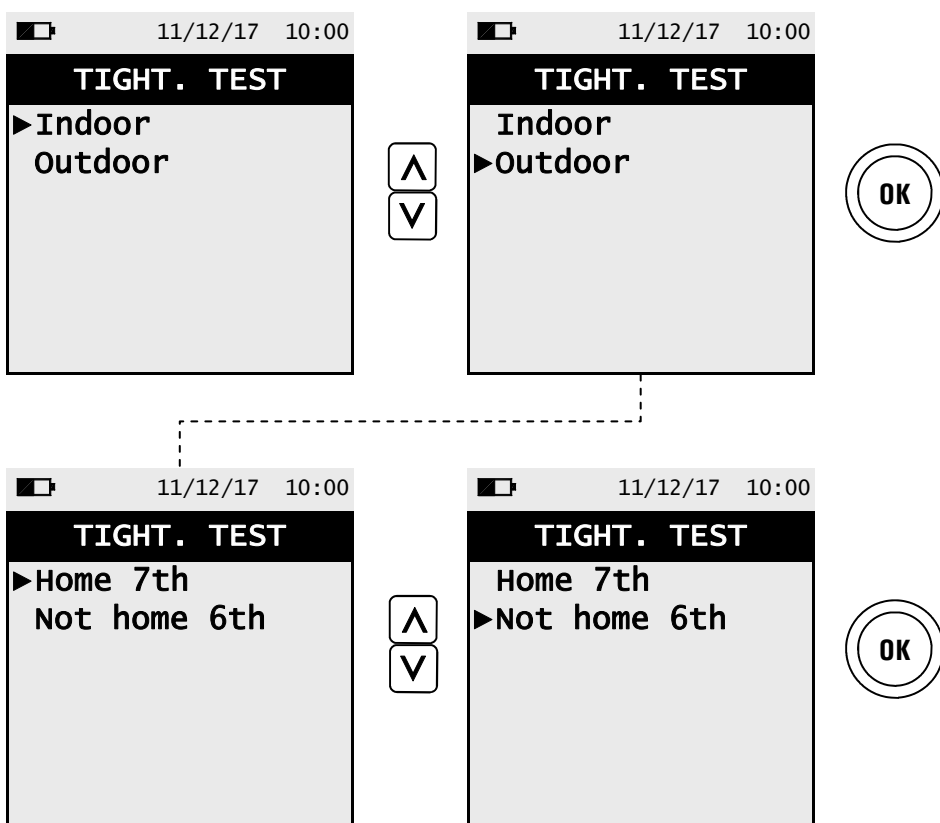

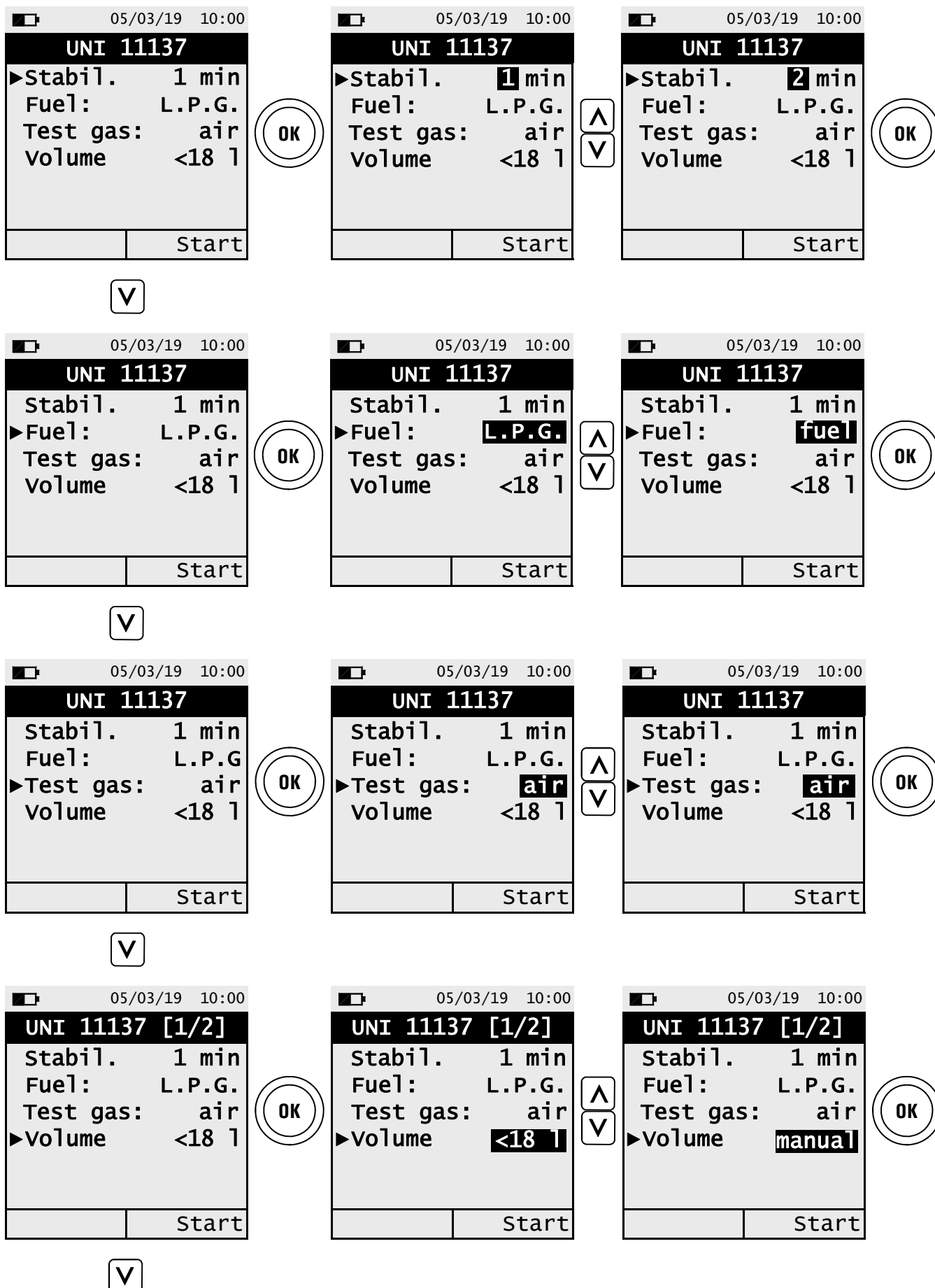

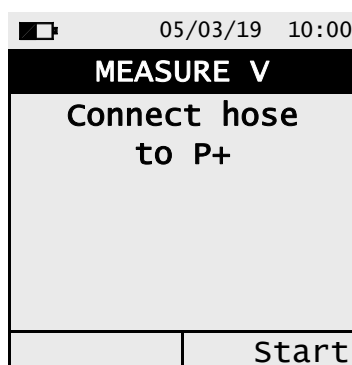
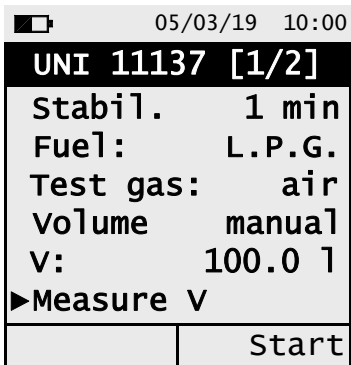
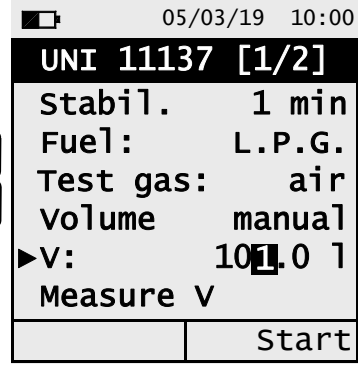
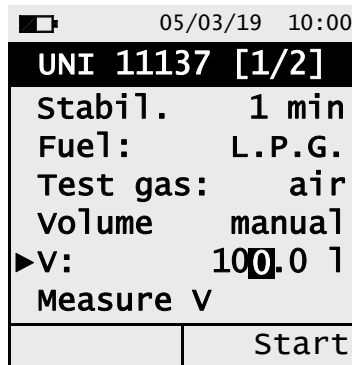
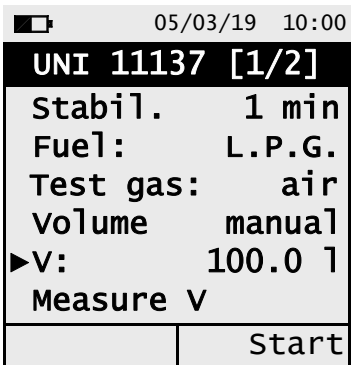

Start

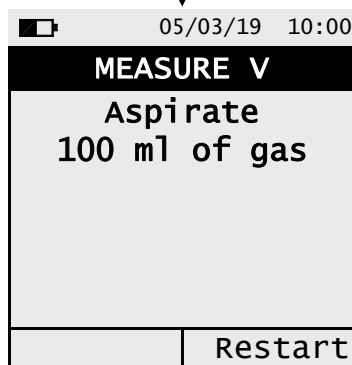
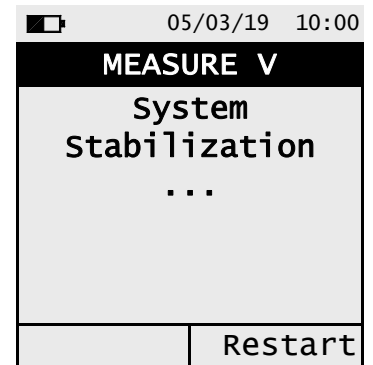

Take, with the syringe (that comes with the tightness test kit), 100 ml of gas.

If the volume measuring procedure of the system ends correctly the GAS T ONE automatically displays the measured volume, otherwise it requires another test.

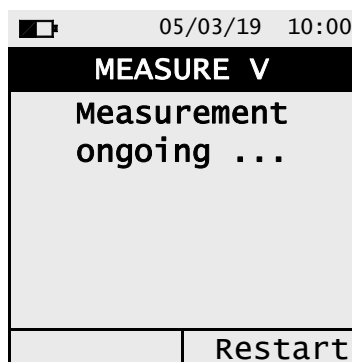

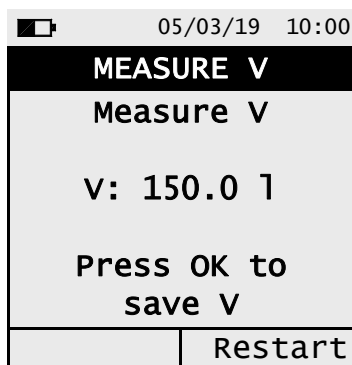

Restart

(allows to repeat the volume measurement)

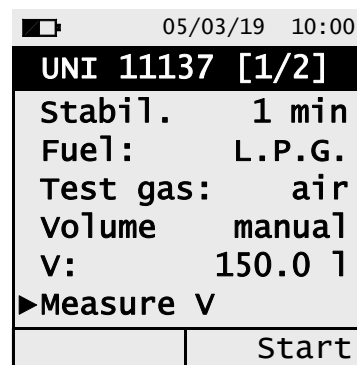

Start

Start tightness test
(see [chapter 9.4.2](#))

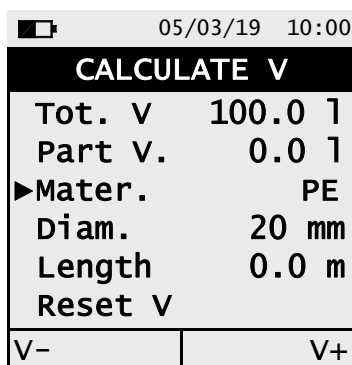
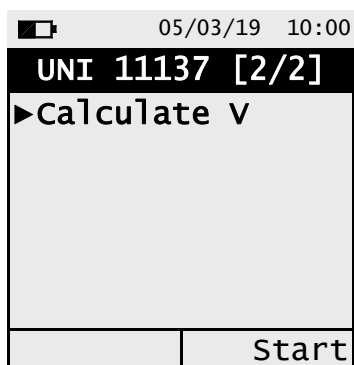

- Total acquired volume
- Volume of the set pipe section
- Set the piping section material
- Set the nominal diameter of the piping section
- Set the piping section length
- Reset the previously acquired volume

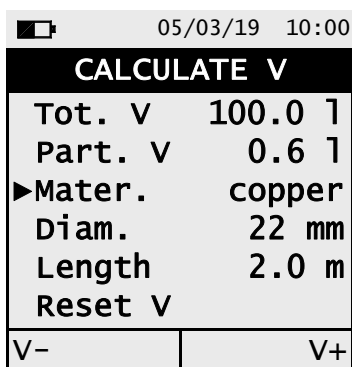

V+

Adds the volume of the set piping section.

V-

Subtracts the volume of the set piping section.

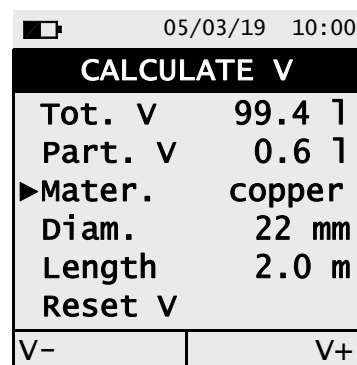
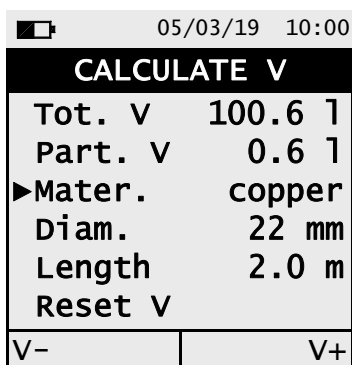

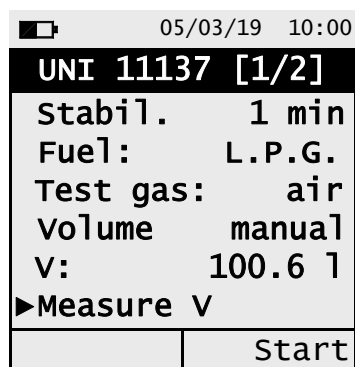
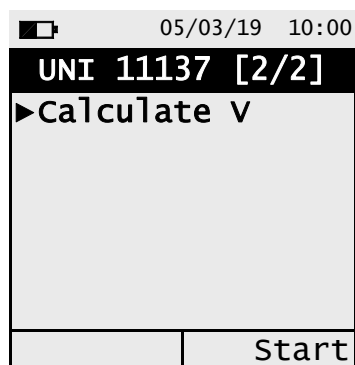

Start tightness test
([see chapter 9.4.2](#)).

9.4.2 TIGHTNESS TEST PERFORMANCE ACCORDING TO STANDARD UNI 11137

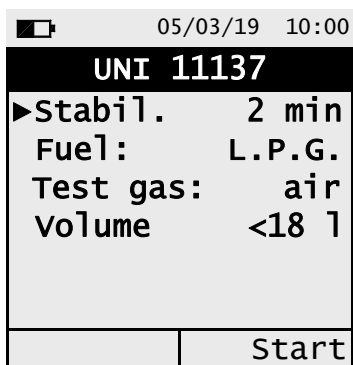

Start

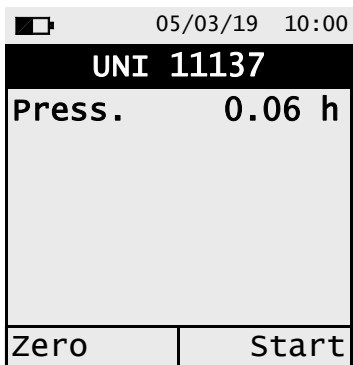
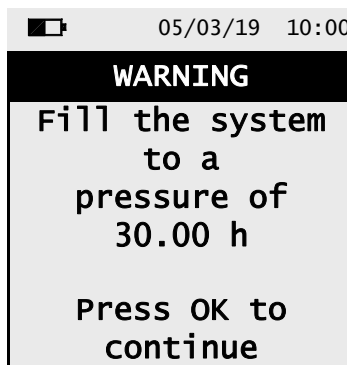

Zero



Wait for the autozero to be finished, then apply pressure to the system and press "Start"

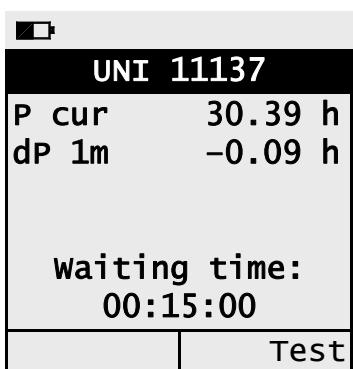

System pressure.

Pressure change in the last minute.

Waiting time to complete the stabilization phase.

Press "TEST" to interrupt the stabilization phase.

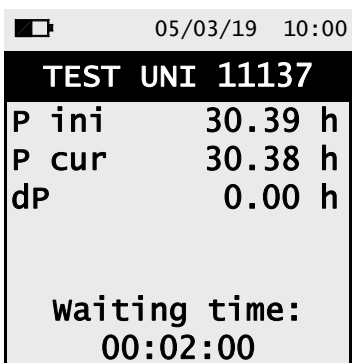

Tightness test result:
Tight or leak

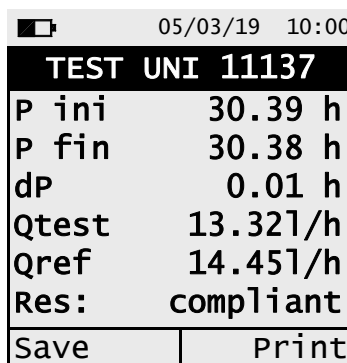

9.5 Measurements menu → Measurements → Tightness test → Result

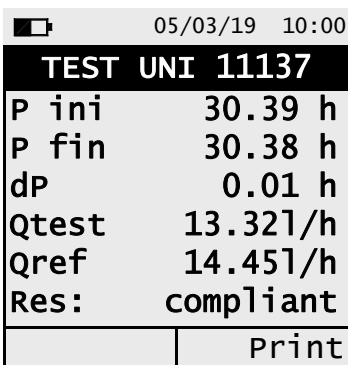
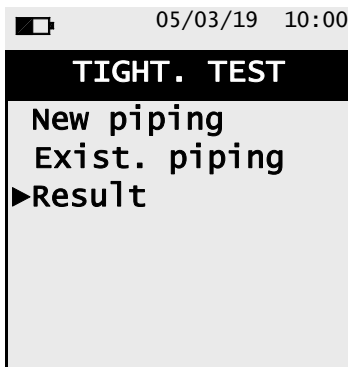
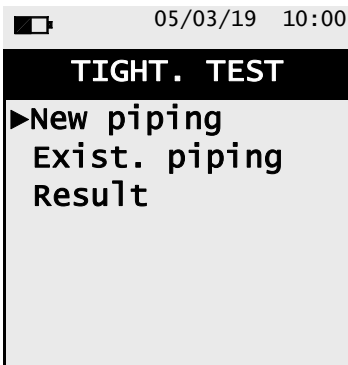

Print



9.6 Measurements menu → Measurements → Pressure

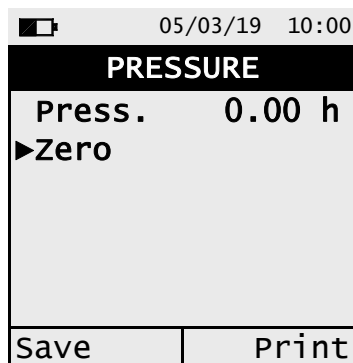

KEY	DESCRIPTION
	Activate the related operations shown on the display.
	Performs the pressure sensor autozero.
	Returns to the previous screen.

INTERACTIVE OPERATIONS	DESCRIPTION
Save	Stores the measured pressure value.
Print	According to the setting made in the relative menu, it is possible to print or display the QR code.

Example:

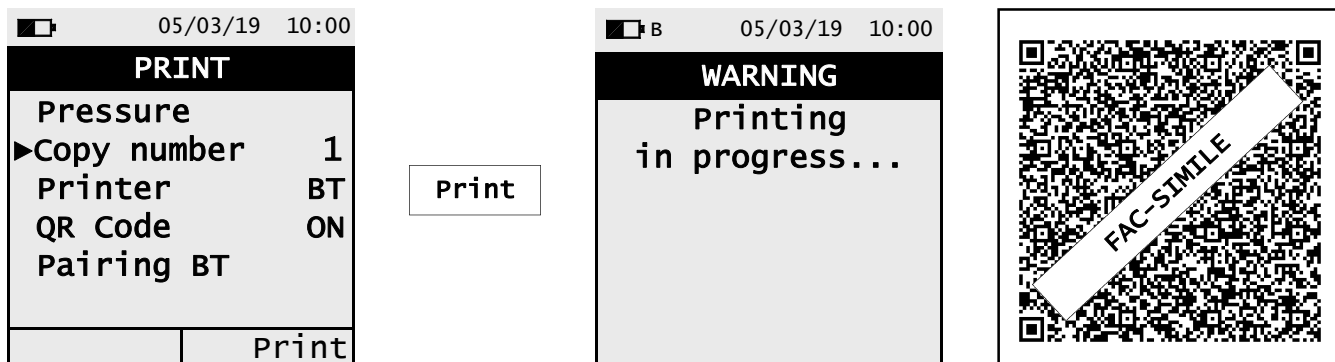
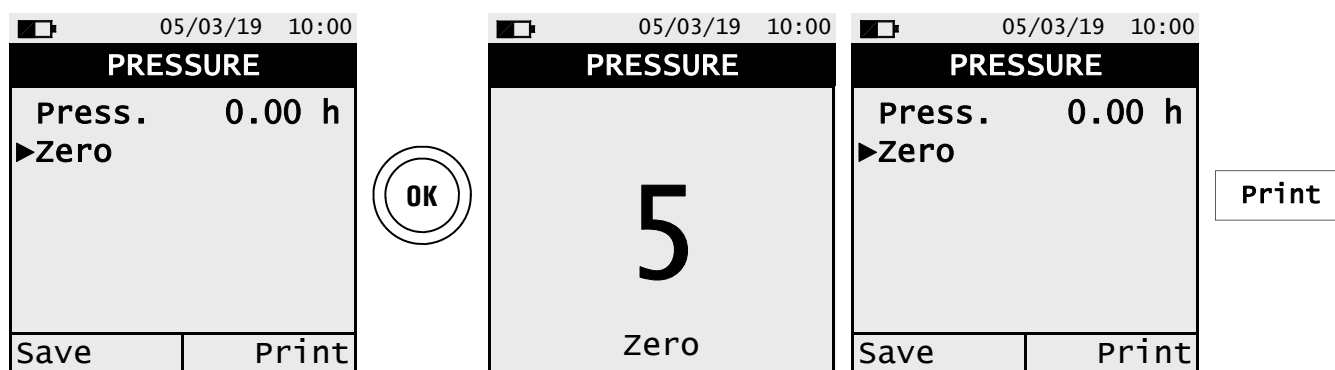

9.7 Measurements menu → Measurements → Temperature

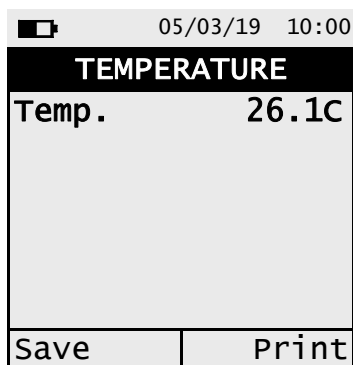

KEY	DESCRIPTION
	Returns to the previous screen.

INTERACTIVE OPERATIONS	DESCRIPTION
Save	Stores in memory the measured temperature value.
Print	According to the setting made in the relative menu, it is possible to print or display the QR code.

Example with probe connected to the instrument:

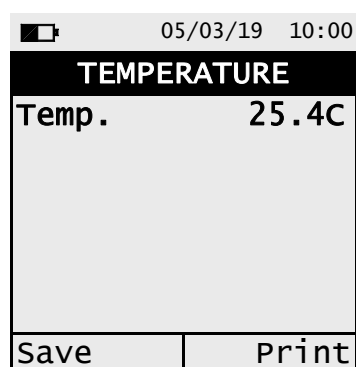

Print

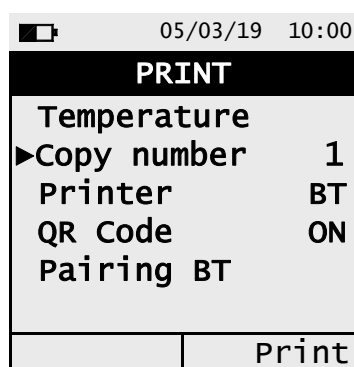

Print

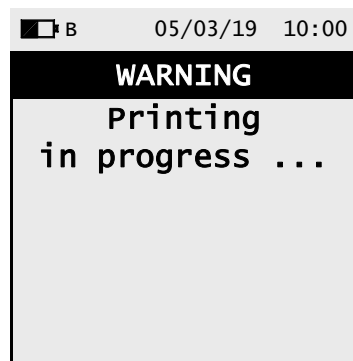

10.1 Parameters menu



KEY	DESCRIPTION
	Returns to the previous screen.
	Selects the available parameters.
	Enters in the selected parameter.

PARAMETER	FUNCTION
Memory	This parameter allows to set the memory number on which to record the tightness test, the temperature measurement, etc. It also displays the status (Full or Free) and the details (time and date) of the selected memory number (if the memory location is occupied by data). In addition, it allows you to view, print or delete stored tests and accessory measures. SEE CHAPTER 11.0
Configuration	The user can set the different reference parameters of the instrument. SEE CHAPTER 12.0
Diagnostic	The user can check for any anomalies in the instrument. SEE CHAPTER 13.0
Info service	View information on the instrument status. SEE CHAPTER 14.0

11.1 Menu→Memory

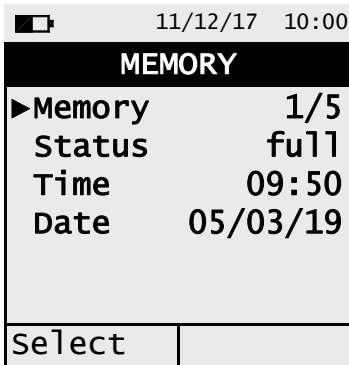

KEY	FUNCTION
	Activate the context keys shown on the display.
	Modifies the memory number and then confirms the changed setting. When selecting the analysis, shows the detail of the evidenced analysis.
 	Selects the available parameters.
	Returns to the previous screen. In modification mode, cancels the setting made.

INTERACTIVE OPERATION	DESCRIPTION
Select	Shows the list of measures within the selected memory number.
Delete	Deletes the entire contents of the selected memory.
Print	Prints the ticket or shows the QR code of the selected memory number.

1. Set memory detail

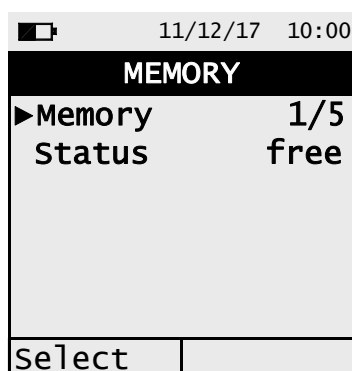
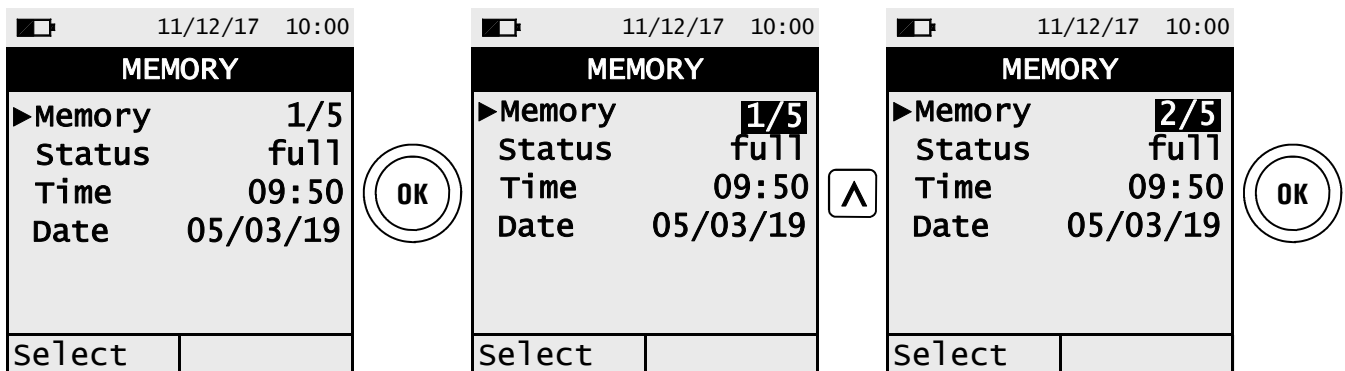

1. Visualization of the memory content

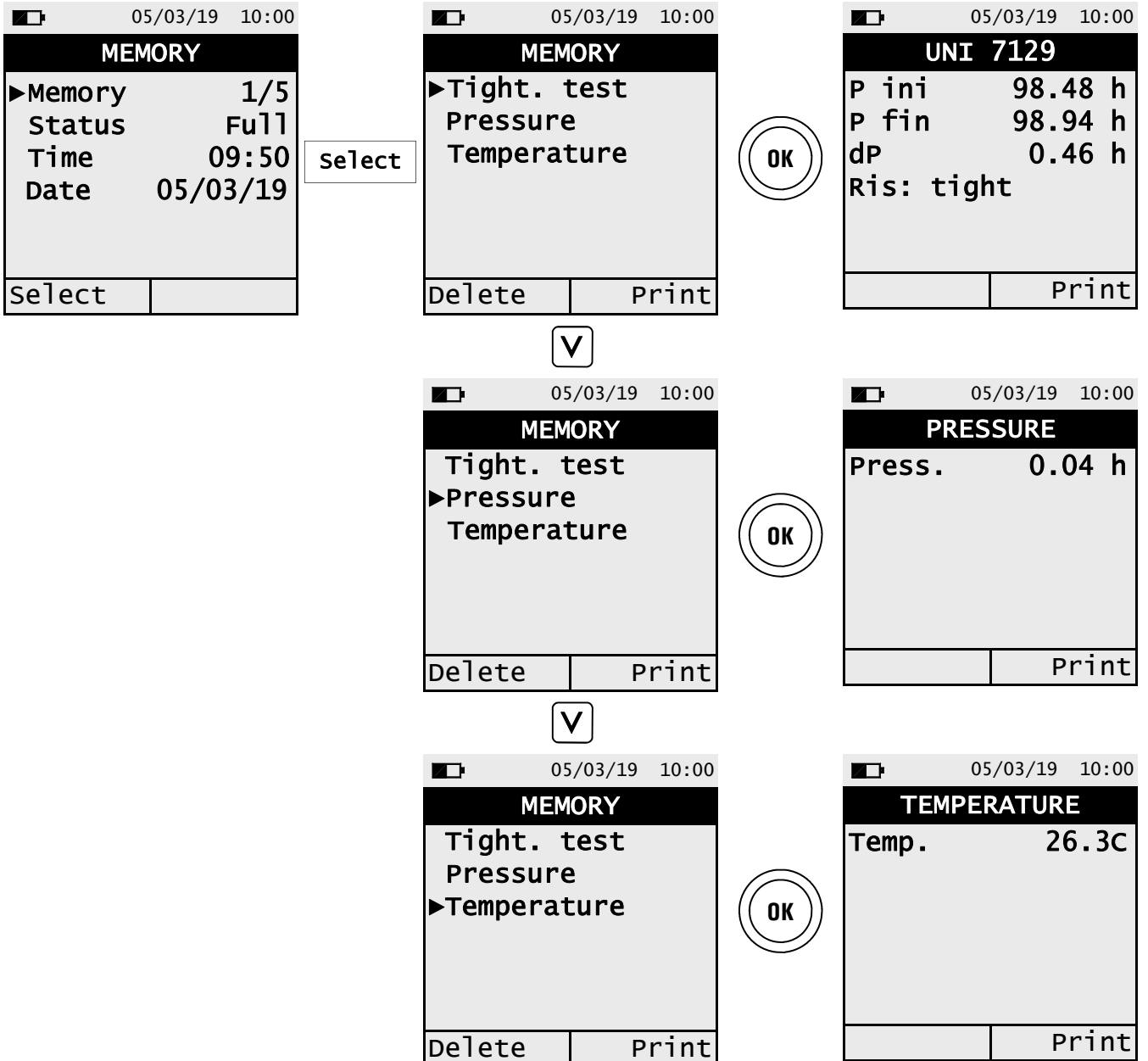

2. Print ticket detail of the entire selected memory

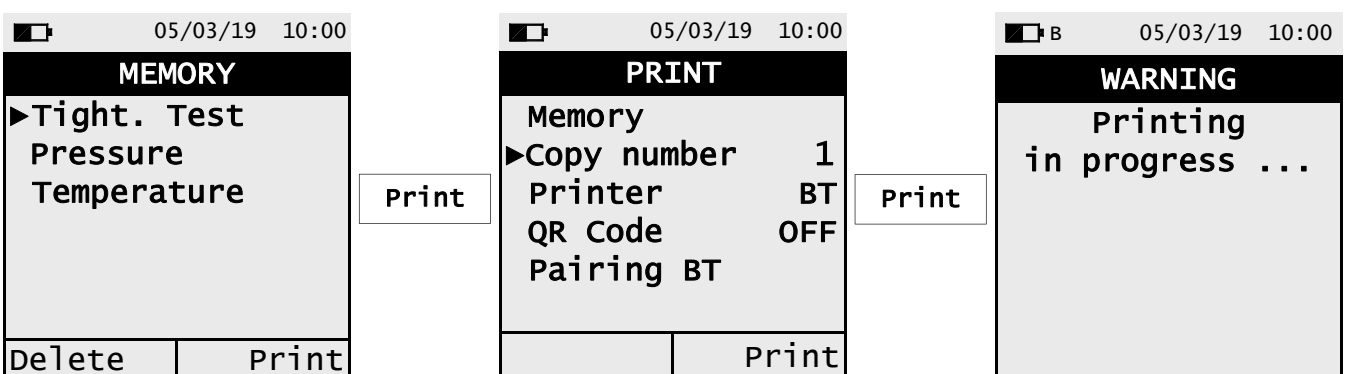

12.1 Menu→Configuration



KEY	FUNCTION
	Enters in the selected parameter.
	Selects the available parameters.
	Returns to the previous screen.

SUB MENU	FUNCTION
Measure unit	In this submenu you have the possibility to change the analysis parameters unit of measurement according to use. SEE CHAPTER 12.2
Instrument	The user, through this menu, can set the different instrument reference parameters. SEE CHAPTER 12.3
Print	This menu allows the user to set the printing parameters, which are: copy number, printer type (OFF, BT or IR) and display the QR code in order to download the performed measures. SEE CHAPTER 12.4
Language	Set the desired language of the different menus. SEE CHAPTER 12.5
Restore	Rest to factory default. SEE CHAPTER 12.6

12.2 Menu→Configuration→Measure units

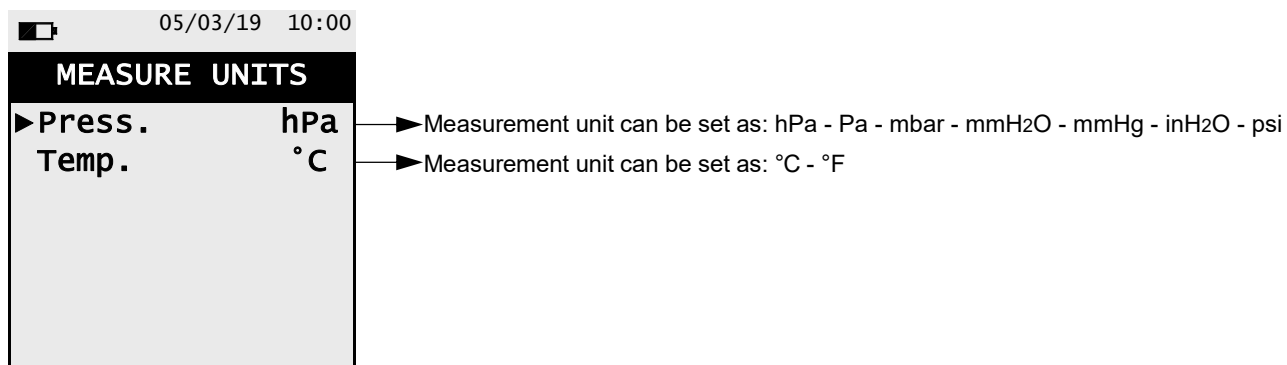



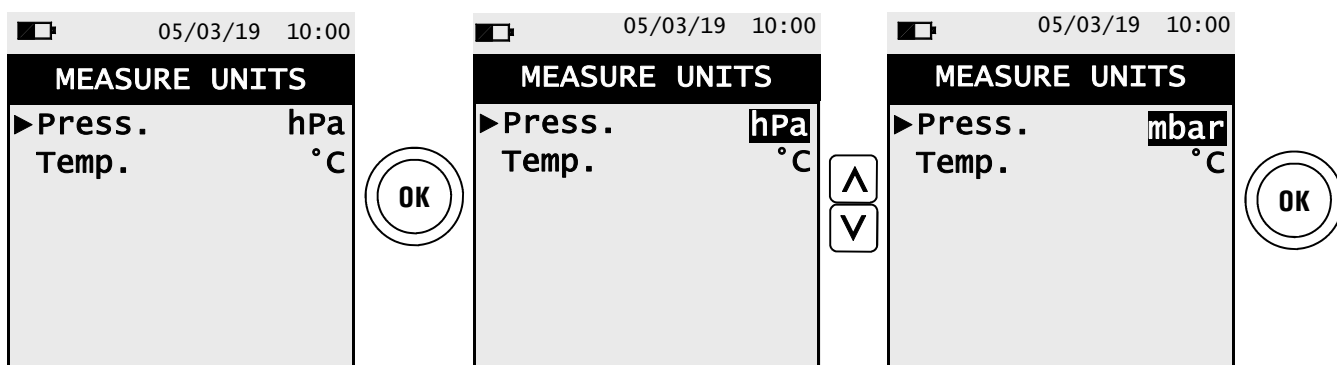

KEY	FUNCTION
	Enters the modify mode for the selected parameter, then confirms the modification.
	The arrows select each line displayed. In edit mode, it scrolls through the suggested values.
	When pressed in modify mode cancels the selection made, otherwise returns to the previous screen.

Example:

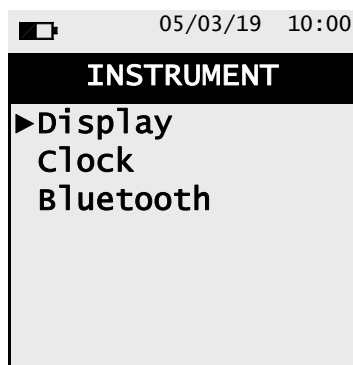

12.3 Menu→Configuration→Instrument



KEY	FUNCTION
	Enters in the selected parameter.
	Selects the available parameters.
	Returns to the previous screen.

SUB MENU	FUNCTION
Display	With the arrow keys it is possible to increase or decrease the brightness and the contrast of the display. SEE CHAPTER 12.3.1
Clock	This allows the current time and date to be set. The user can select the date and hour format either in EU (European) or USA (American) mode. SEE CHAPTER 12.3.2
Bluetooth	In this sub menu it is possible to turn on and off the Bluetooth® communication of the instrument and to display the related codes. SEE CHAPTER 12.3.3

12.3.1 Menu→Configuration→Instrument→Display

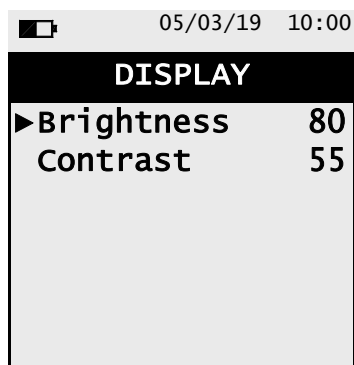

KEY	FUNCTION
	When pressed in modify mode cancels the selection made, otherwise returns to the previous screen.
	The arrows select each line displayed. In edit mode, it scrolls through the suggested values.
	Enters the modify mode for the selected parameter, then confirms the modification.

Example:

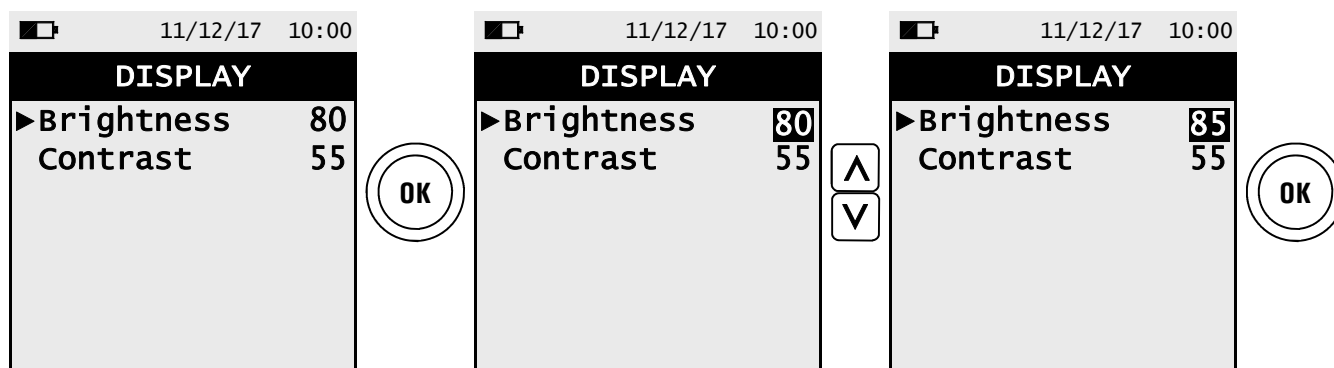

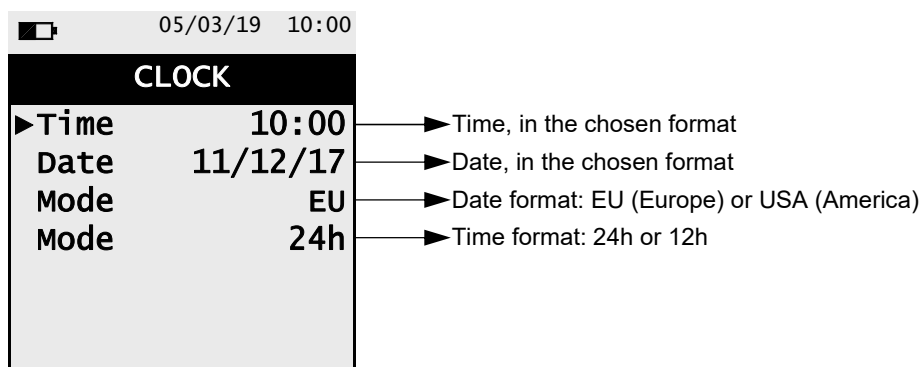

12.3.2 Menu→Configuration→Instrument→Clock



05/03/19 10:00

CLOCK

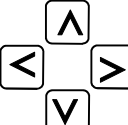
- ▶ Time 10:00 → Time, in the chosen format
- Date 11/12/17 → Date, in the chosen format
- Mode EU → Date format: EU (Europe) or USA (America)
- Mode 24h → Time format: 24h or 12h

KEY	FUNCTION
	When pressed in modify mode cancels the selection made, otherwise returns to the previous screen.
	Selects line; in setting mode, sets the value or the desired mode.
	Enters the modify mode for the selected parameter, then confirms the modification.

12.3.3 Menu→Configuration→Instrument→Bluetooth

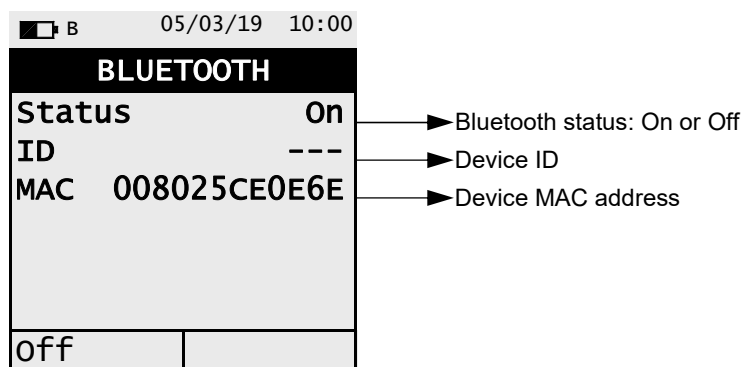

05/03/19 10:00

BLUETOOTH



Status On

ID ---

MAC 008025CE0E6E

Off

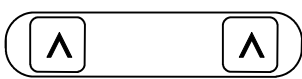

- Bluetooth status: On or Off
- Device ID
- Device MAC address

KEY	FUNCTION
	Activate the context keys shown on the display.
	Goes back to the previous screen.

INTERACTIVE OPERATIONS	DESCRIPTION
Off	Turns off Bluetooth®.
On	Turns on Bluetooth®.

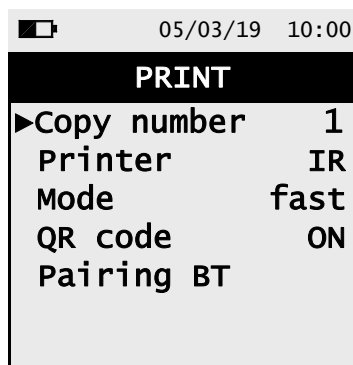
12.4 Menu→Configuration→Print



KEY	FUNCTION
	Enters the modification mode of the selected data and then confirms it.
	Selects the available parameters. In modification mode, scrolls the available values.
	When pressed in modify mode cancels the selection made, otherwise returns to the previous screen.

PARAMETER	DESCRIPTION
Copy number	Sets the number of ticket copy to be printed. This is a valid setting only if a printer has been selected.
Printer	Select the type of printer with which the ticket is printed: BT: Bluetooth® - at the first start up it is necessary to perform the pairing procedure described below. IR: Infrared. OFF: none - the printer is turned off.
Mode	This parameter is visible only if the IR printer has been selected. Selects the printing speed of the IR printer between 'fast' and 'slow'. Select 'slow' in order to make the printing process compatible when an HP IR printer is used.
QR code	<p>QR code generation:</p> <p>ON: pushing the button related to the interactive function "Print" the instrument generates a QR code, which can be read with the App "SEITRON SMART ANALYSIS" allows to download the acquired data related to the tightness test, pressure and temperature.</p> <div style="border: 1px solid black; padding: 5px;">  <p>WARNING! The QR code contains the data related to a complete memory position or the current tightness test and / or current measures.</p> </div> <p>OFF: the QR code will not be shown.</p>
Pairing BT	Carry out the instrument association procedure to pair the Bluetooth® printer.

12.4.1 Menu→Configuration→Print→IR Printing

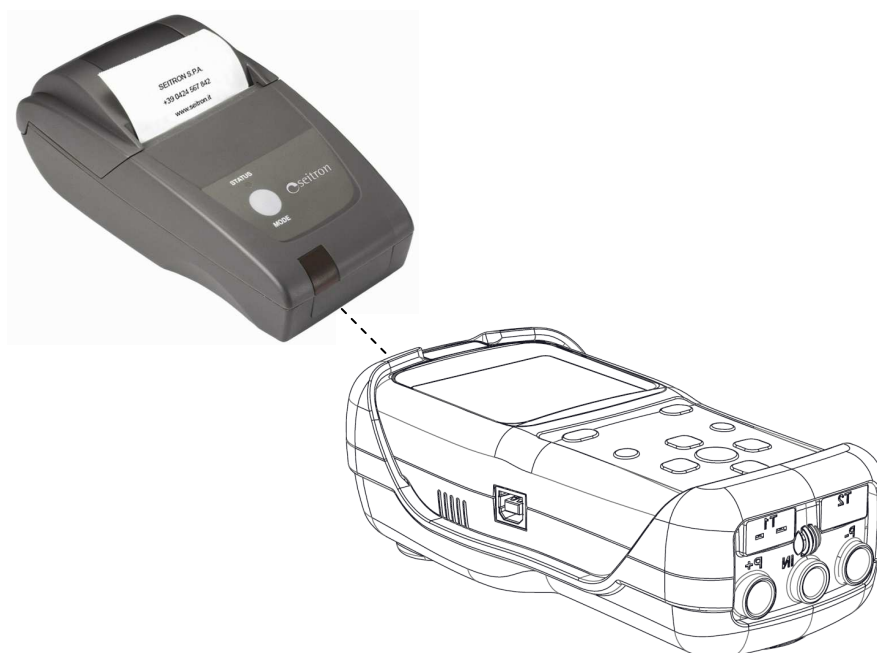

WARNING!

Place the IR printer and the instrument according to the diagram shown on the left. The IR interfaces should be one in front of the other and far apart not more than 30 cm for a good communication result.

12.4.2 Menu→Configuration→Print→Pairing

1. When the Bluetooth printer is set, start the following procedure:

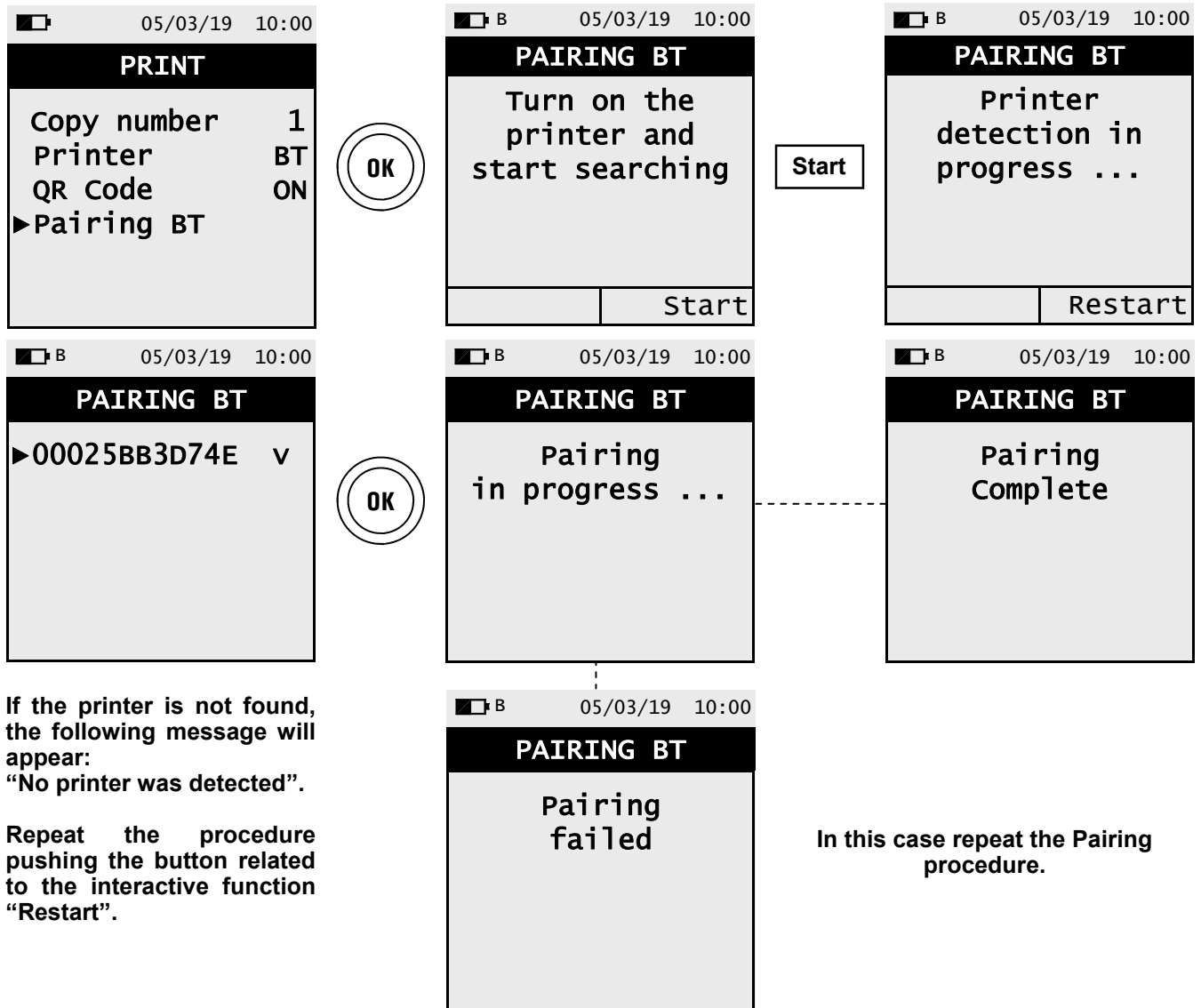

If the printer is not found, the following message will appear:
"No printer was detected".

Repeat the procedure pushing the button related to the interactive function "Restart".

12.5 Menu→Configuration→Language

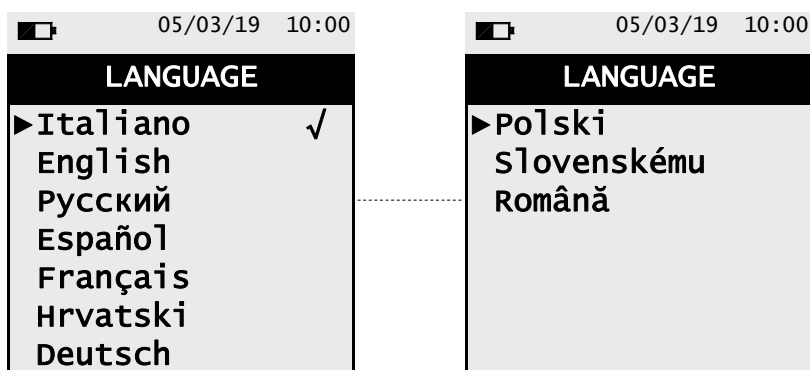

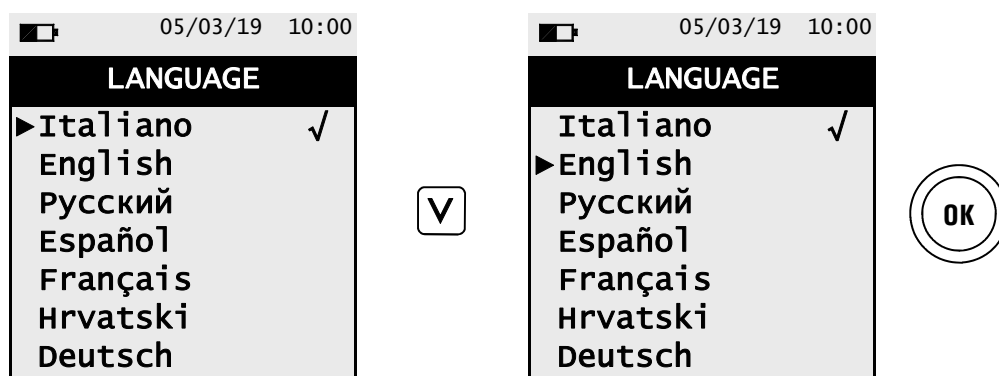

KEY	FUNCTION
	Sets the selected language.
	Scrolls through the available languages.
	Returns to the previous screen.

Example:

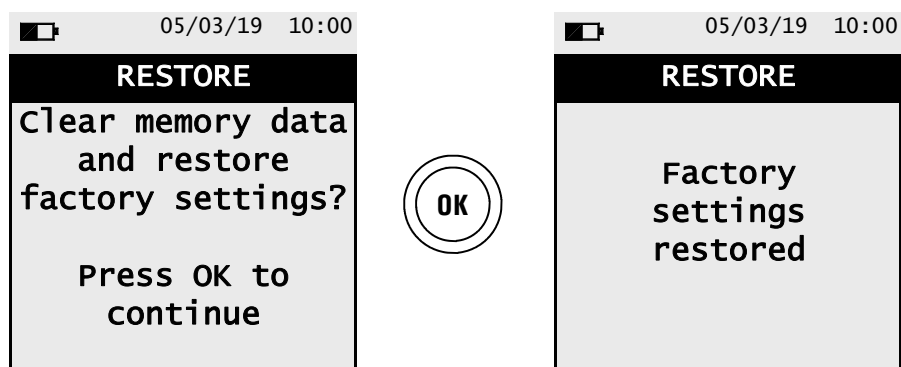

12.6 Menu→Configuration→Restore



KEY	FUNCTION
	Starts the factory data reset phase.
	Exits the current screen without resetting.

13.0 DIAGNOSTIC

13.1 Menu→Diagnostic

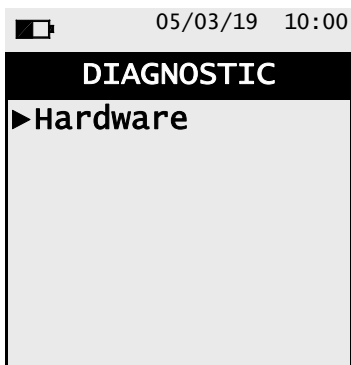

KEY	FUNCTION
	Enters in the selected parameter.
	Selects the available parameters.
	Returns to the previous screen.

SUB MENU	DESCRIPTION
Hardware	In case of malfunction, before contacting the Assistance center prepare and/or send the data shown in this menu. SEE CHAPTER 13.2

13.2 Menu→Diagnostic→Hardware



KEY	FUNCTION
	Enters in the selected parameter.
	Selects the available parameters.
	Returns to the previous screen.

INTERACTIVE OPERATIONS	DESCRIPTION
mV	Shows the values in mV.
Bit	Shows the values in Bit.

Note: the memory and calibration parameters are not accessible if their condition is OK.

Display examples:

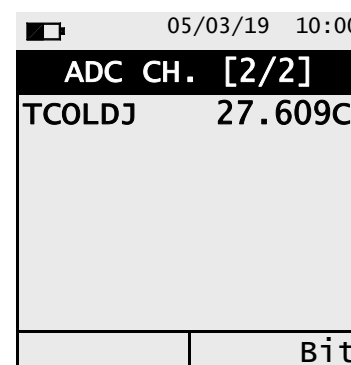
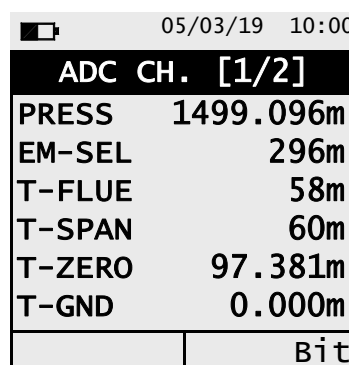
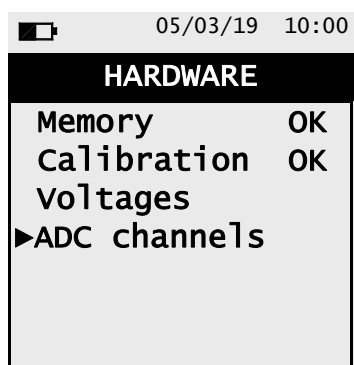
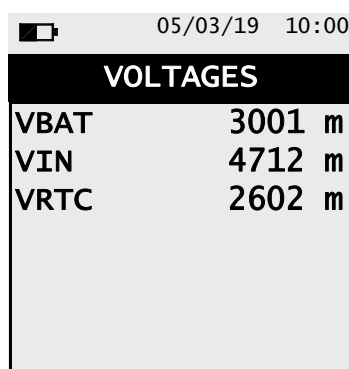
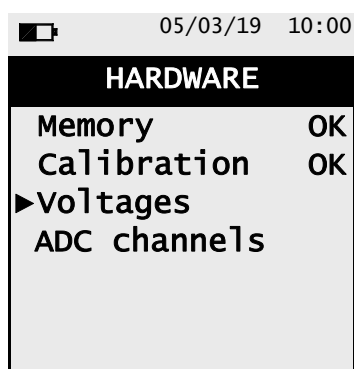

14.1 Menu→Info service

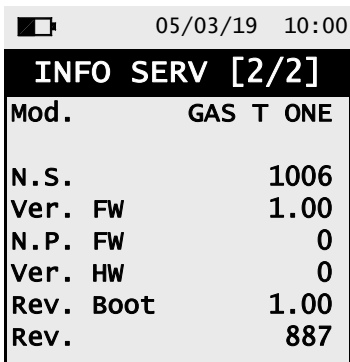

KEY	FUNCTION
	Returns to the previous screen.
 	Toggle view between next or previous screen.

15.1 Routine maintenance

This instrument is designed and manufactured with high quality materials. Proper and systematic maintenance will prevent malfunctions and will increase the instrument life in general. Do not clean the instrument with abrasive cleaners, thinners or other similar detergents.

15.2 Programmed maintenance

It is advised, at least once a year, to send the instrument to a SERVICE CENTER for a calibration check. SEITRON highly qualified staff is always at your disposal and will provide you with all the sales, technical, application and maintenance details required. The service centre will always return the instrument to you as new and in the shortest time possible. Calibration is performed using gases and instruments comparable with National and International Specimens.

15.3 Replacing the battery pack

Follow these instructions to replace the battery pack:

- 1 Remove the base of the instrument.

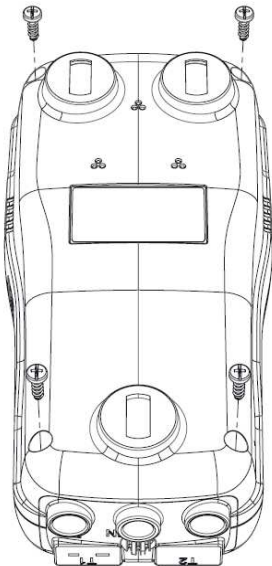

- 2 Extract the battery pack.

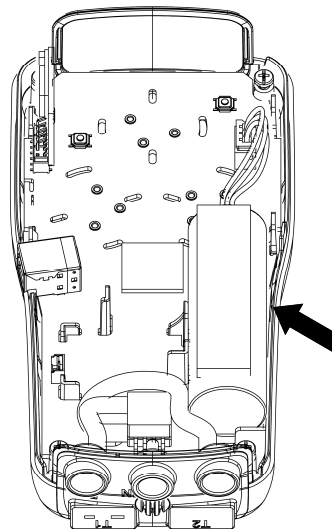

- 3 Remove the battery pack connector, and replace the pack with a new one following the reverse procedure described above.

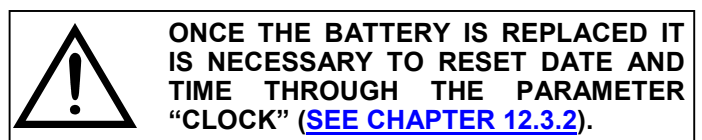
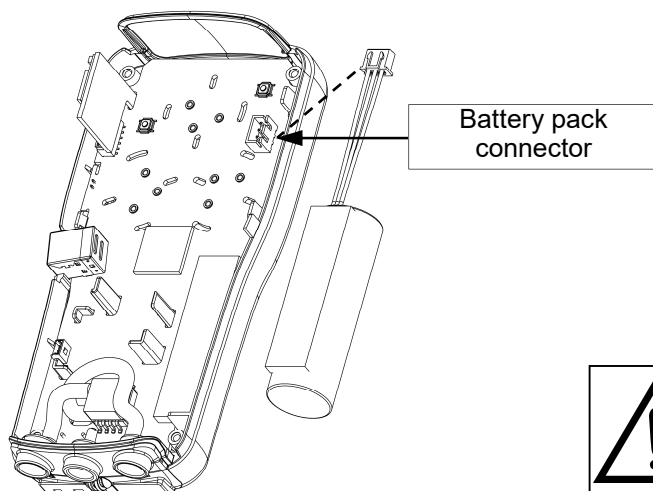



15.4 Firmware Update

The manufacturer periodically releases firmware updates of the instrument in order to correct unavoidable mistakes or improve the instrument performance or add new functions.

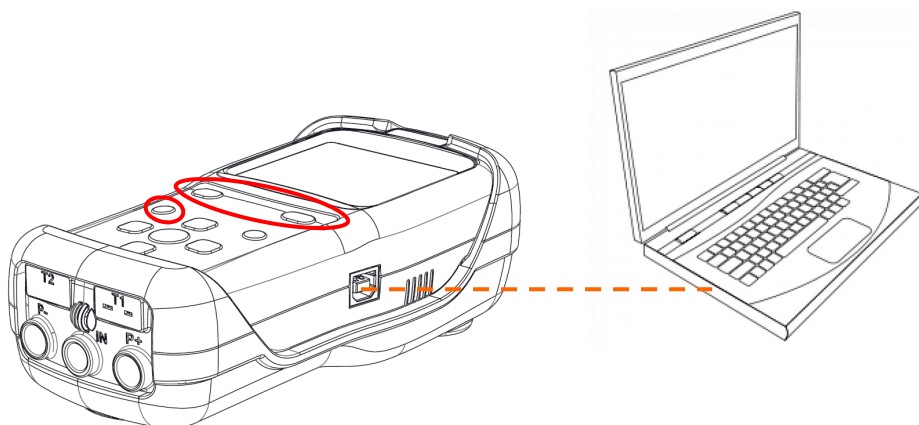

This update can be performed by the user by following the simple instructions below.

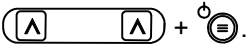
Instructions to update the tightness test instrument with new firmware:



1. Log in to the website www.seitron.com and download the firmware file available in the "DOWNLOAD - Software e firmware - GAS T ONE" section or at the following link:
<http://seitron.it/en/content/gas-t-one-software-e-firmware>
This file is in a compressed version .zip.
2. Unzip the file thus obtaining the contents of the .zip file (extension .srec).
3. Plug in the analyzer to the PC via the USB cable.
4. Hold down the three red buttons on the analyzer for at least 10 seconds:

5. The display turns off.
6. Release only the power  button.
6. The analyzer will be recognized by the operating system as a portable device drive: the display starts blinking.
7. Release the remaining two buttons.
8. Copy the firmware file (extension .srec) to the directory of the analyzer: the display continues to blink faster.
9. Wait till the end of the file copy operation.
10. The file copy directory will be closed and the analyzer will restart.
11. The analyzer is now updated, it can be powered off and it can be unplugged from the PC.

16.1 Troubleshooting guide

SYMPTOM	PROBABLE CAUSES AND REMEDIES
The instrument does not work at all. When the button is pushed, nothing happens. 	<ol style="list-style-type: none"> Press the  button for at least 2 seconds. The battery is low; connect the battery charger to the instrument. The battery pack is not connected to the instrument. Access the internal parts of the instrument and verify that the connector of the battery pack is inserted in the proper connector (SEE CHAPTER 15.3). The instrument is faulty: send it to a service centre.
The battery symbol is empty on the inside and blinking.	The batteries are low. The instrument will remain on for a couple of minutes after which it will switch off; connect the battery charger.
The instrument battery autonomy is lower than what stated in the “Technical features” chapter.	<ol style="list-style-type: none"> The battery capacity is limited at a low temperature. To obtain a greater autonomy it is advised to keep the instrument in higher temperatures. Perform a 100% complete charge cycle connecting the instrument to the plug for at least 6 hrs. The battery pack is old. Aging can cause the batteries to reduce their capacity. If the autonomy has become unacceptable change the internal battery with an original part SEITRON. Verify the measured voltage values in “Menu→Diagnostic→Hardware→Voltages”: <ul style="list-style-type: none"> - If VBAT<3000mV: the battery needs to be changed. - If VIN<4700mV: the output voltage of the battery charger is not sufficient to recharge the instrument battery. In this case verify the connections and the plate data of the battery charger in use: 5Vdc 2A. If the problem keeps on happening contact the SERVICE CENTER.
Date and time are not memorized.	<ol style="list-style-type: none"> Verify the voltage value VRTC showed in “Menu→Diagnostic→Hardware→Voltages”: If <2600mV contact the SERVICE CENTER. The battery is completely drained (VBAT<2500m)
When measuring the pressure, on the screen appears error ERR.CAL.	There is a calibration problem. Send the instrument to the service center.
The backlight does not turn on.	The instrument is faulty: send it to a service centre.
The display, when measuring temperature, shows the message: Temp. --- C.	The probe for the temperature measurement is not plugged in.
The display, when measuring temperature, shows the message: Temp. up lim	The detected temperature is above the upper limit.
The display, when measuring temperature, shows the message: Temp. low lim	The detected temperature is under the lower limit.
The display, when measuring pressure, shows the message: Press. up lim	The detected pressure is above the upper limit.
The display, when measuring pressure, shows the message: Press. low lim	The detected pressure is under the lower limit.

17.1 Spare parts

CODE	DESCRIPTION
AA PB13	Li-Ion battery pack 7,2V 2,4Ah
AA AL05	Power supply 100-240V~/12 VDC 2A with 2 meters cable
AA SI01	EU plug
AA CR09	Rigid plastic case
AA SM07	Rubber protective cover

17.2 Accessories

CODE	DESCRIPTION
AAC KP02	Pressure measurement kit
AA KT05	Tightness test kit for gas installations
AA UA01	Adapter cable USB-A / USB-B
AA SA08	TcK external air temperature sensor, 200 mm length and 2 meters cable

17.3 Service Centers

Seitron S.p.A. a socio unico

Via del Commercio, 9/11
36065 Mussolente (VI)
Tel.: +39.0424.567842
Fax.: +39.0424.567849
E-mail: info@seitron.it
<http://www.seitron.com>

Seitron Service Milano

Via Leonardo da Vinci, 1
I-20090 Segrate (MI)
Tel. / Fax: +39.02.836.476.71
E-mail: service.milano@seitron.it



Data Management with “SEITRON SMART ANALYSIS” APP

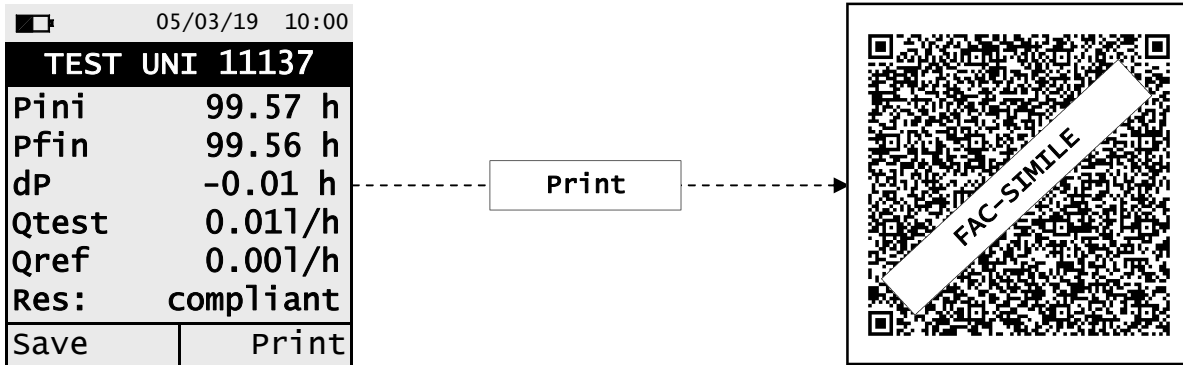

SCAN THE QR CODE USING APP “SEITRON SMART ANALYSIS”, TO DOWNLOAD THE ACQUIRED DATA.

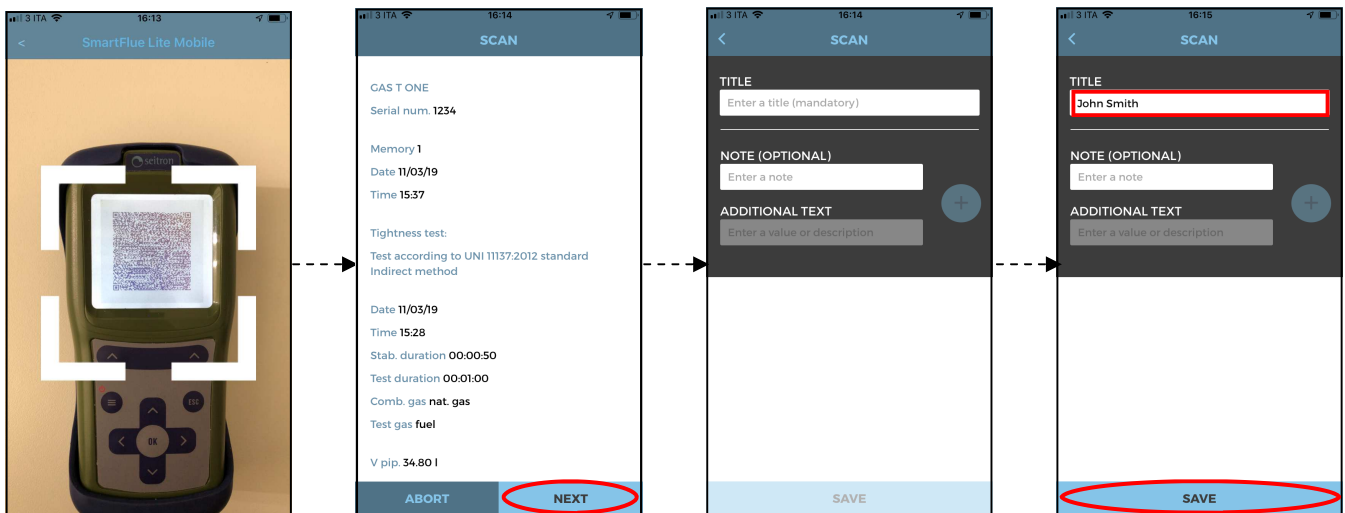

THE ACQUIRED DATA ARE SAVED IN THE INSTRUMENT MEMORY.

APP settings.



- Insert a default email address.
- Select the data separation mode: comma (,) or semicolon (;). This setting is useful if it's needed to import the csv file in an electronic sheet such as Excel or google drive.
- Visualize the version of the APP and Seitron contacts.

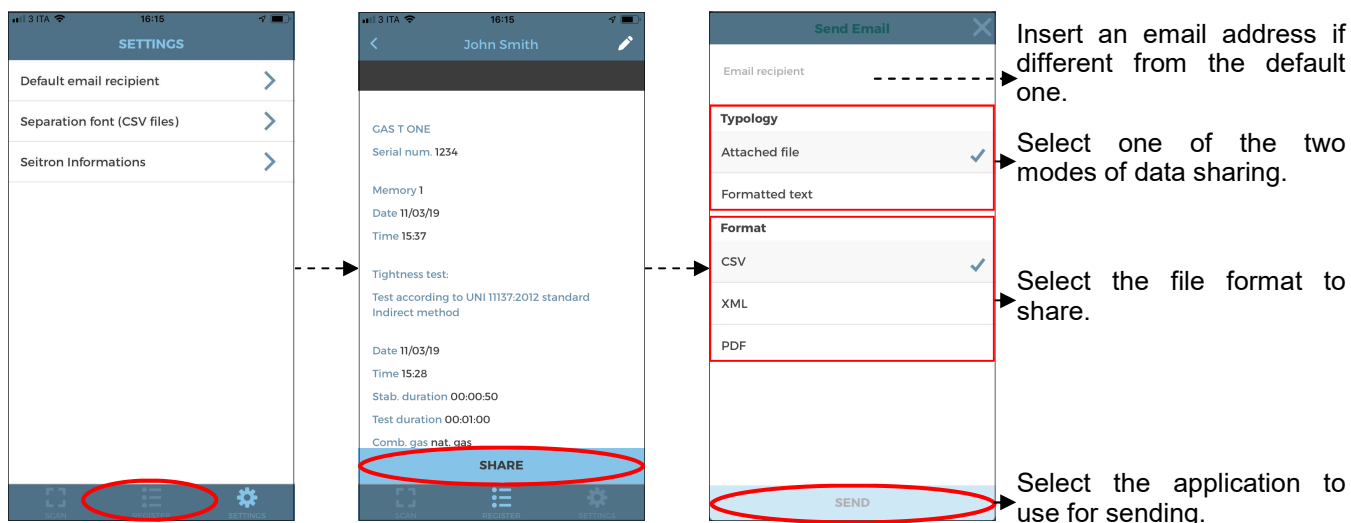

Example of the exported csv file and imported in an excel file:

GAS T ONE		
Serial number	1234	
Date	11/03/2019	
Time	9:43	
Stab. Time	00.02.00	
Test duration	00.01.00	
Comb. gas	nat. gas.	
Test gas	fuel	
V pip.	<18 l	
P ini	99.57 h	
P fin	99.56 h	
dP	-0.01 h	
Qtest	0.01 l/h	
Qref	0.00 l/h	
Result:	Compliant	

<p>Tel. (+39).0424.567842 Fax. (+39).0424.567849</p>	DICHIARAZIONE DI CONFORMITA' UE EU DECLARATION OF CONFORMITY	<p>Nr. 031793 Pag. 01 di 01</p>
<p>Nome del fabbricante: Seitron S.p.A. a socio unico <i>Constructor name:</i></p> <p>Indirizzo del fabbricante: Via del Commercio, 9/11 <i>Constructor address:</i> 36065 MUSSOLENTE (VI) ITALIA</p> <p>dichiara sotto la propria esclusiva responsabilità che il seguente prodotto: <i>declares under its sole responsibility that following product:</i></p> <p>Nome del prodotto: POMX01 <i>Product name:</i> Strumento per prova tenuta impianti <i>Instrument for installations tightness test</i></p> <p>Versioni del prodotto: Tutte <i>Product versions:</i> All Nomi commerciali: GAS T ONE <i>Sales models:</i></p> <p>e' conforme alla pertinente normativa di armonizzazione dell'Unione: <i>is in conformity with the relevant Union harmonisation legislation:</i></p> <p>EMC (2014/30/UE):</p> <p style="padding-left: 40px;">Immunità: EN 61000-6-1 (2007) <i>Immunity:</i></p> <p style="padding-left: 40px;">Emissione: EN 61000-6-3 (2007) <i>Emission:</i></p> <p>RoHS2 (2011/65/UE): EN 50581 (2012)</p> <p>Note aggiuntive: Lo strumento è conforme alle norme italiane UNI 7129, per la prova di tenuta di impianti nuovi ed UNI 11137, per la prova di tenuta in impianti già esistenti. <i>Further notes:</i> <i>This instrument is compliant with the requirements of the Italian standard UNI 7129, for tightness test on new installations, and UNI 11137, for tightness test on pre-existing installations.</i></p> <p>Mussolente, li 04/03/19</p> <div style="text-align: right; margin-top: 20px;"> <p>Ing. Vito Feleppa Amministratore Delegato Seitron S.p.A. a socio unico</p> </div>		
<p>Seitron S.p.A. a socio unico Via del Commercio, 9/11 36065 Mussolente (VI) Italy Tel. (+39).0424.567842 Fax. (+39).0424.567849</p>		

WARRANTY CERTIFICATE

WARRANTY

The GAS T ONE tightness test kit is guaranteed for **24 months** from purchasing document date. Seitron undertakes to repair or replace, free of charge, those parts that, in its opinion, are found to be faulty during the warranty period. The products which are found defective during the above mentioned periods of time have to be delivered to Seitron Laboratories carriage paid. The following cases are not covered by this warranty: accidental breakage due to transport, inappropriate use or use that does not comply with the indications in the product's instruction leaflet. Any mistreatment, repairs and modifications to the product not explicitly authorized by Seitron shall invalidate the present warranty.

IMPORTANT

For the product to be repaired under Warranty, please send a copy of this Certificate along with the instrument to be repaired, together with a brief explanation of the fault observed.

Space reserved for user

Name: _____

Company: _____

User's notes:

Date: _____

S.N.:



SEITRON S.p.A. a socio unico

Via del Commercio, 9/11 36065 - Mussolente (VI) ITALY

+39 0424 567 842 - info@seitron.it - www.seitron.com