

USE AND MAINTENANCE



 **be safe MG ----**

Portable Multi-Gas Detector

INDICE

1.0	IMPORTANT INFORMATION	5
1.1	Information about this manual	5
1.2	Safety warnings	5
2.0	SAFETY	6
2.1	Precautionary Safety Measures to Adopt	6
3.0	TECHNICAL FEATURES	9
3.1	Dimensions	9
4.0	MEASUREMENT RANGES AND SENSOR ACCURACY	10
5.0	SENSOR POSITION	10
6.0	PRODUCT DESCRIPTION	11
6.1	Product code table	11
6.2	General features	11
6.3	Available software	11
6.4	Calibration Certificate	11
6.5	MECHANICAL DESCRIPTION	12
6.6	Definition of Multifunction Buttons	13
6.7	LED Definition	13
6.8	Display icons and values setup	14
6.9	Backlighting	15
6.10	Vibration Alarm	15
6.11	Acoustic Alarm	15
6.12	Visual Alarm	15
6.13	Toxic Gas Monitoring	15
6.14	Oxygen Concentration Monitoring	15
6.15	Flammable Gas Monitoring	16
6.16	Data Logging	16
7.0	COMMISSIONING	17
7.1	Preliminary Operations	17
7.2	Battery Charging and Indications	17
7.3	Mounting the Bump Test / Calibration Adapter	19
7.4	Mounting the External Filter	19
8.0	OPERATION	20
8.1	Powering On/Off the Instrument	20
8.1.1	Startup Phase of the Instrument	20
8.1.2	Minimum instrument configuration	23
8.2	Autozero	23
8.3	Alarms	24
9.0	BUMP TEST	27
9.1	Connecting the instrument to the cylinder	27
9.2	Menu setting "Bump Test Cylinder Conc."	28
9.3	Performing a Bump Test	29
10.0	CALIBRATION OF THE SENSORS	33
10.1	Connecting the instrument to the cylinder	33
10.2	Setting up the "Setup cal gas" Menu	34
10.3	Calibration Procedure	36
11.0	MENU	41
11.1	Bump Test	42
11.2	Bump Test Cylinder Conc.	42
11.3	Setup cal gas	42
11.4	Calibration	42
11.5	Units setup	42
11.6	Alarms	43
11.6.1	Low Alarm Setup	44
11.6.2	High Alarm Setup	45
11.6.3	STEL Alarm Setup	46

11.6.4	TWA Alarm Setup	47
11.7	Combustible	48
11.8	Data logging	49
11.9	Language	50
11.10	Clock	51
11.11	Device Info	52
11.12	Service	52
11.13	Reset Password	52
11.14	Operator	52
11.15	Diagnostics	53
11.16	Debug Service	53
12.0	MAINTENANCE	54
12.1	Routine maintenance	54
12.2	Cleaning	54
12.3	Scheduled maintenance	54
12.4	Replacing gas sensors	54
12.5	Replacing gas sensor filters	54
12.6	Instrument expandability	54
12.7	Replacing the internal battery	54
13.0	TROUBLESHOOTING AND FAULTS	55
13.1	Troubleshooting	55
14.0	SPARE PARTS AND SERVICE	56
14.1	Spare parts	56
14.2	Accessories	56
14.3	Service centers	56
APPENDIX A	AMDS01 (BATTERY CHARGING AND COMMUNICATION STATION)	57
1.1	Mechanical description	57
1.2	Dimensions	57
1.3	Technical Features	58
1.4	Charging station use and communication	58
APPENDIX B	Software PC "Be Safe MG Manager"	59
	Instructions for installing the software	59
	Connect Be Safe MG	60
	User's Guide	61
APPENDIX C	AMSD01 (MOUNTING BRACKET FOR AMDS01)	71
1.0	Mechanical Description	71
1.2	Technical Features	71
1.3	Mounting the Support on DIN Rail	71
1.4	Wall mounting	72

1.0 IMPORTANT INFORMATION

1.1 Information about this manual

- ◇ This manual describes the operation, features, and maintenance of the device.
- ◇ This manual must be read and followed carefully when using the product. In particular, safety instructions and information on the use and operation of the product must be read and followed carefully. Additionally, to ensure safe use, national regulations in force must be respected.



Respect the environment, think before printing the full manual.

1.2 Safety warnings



WARNING!

Carefully read the information and take adequate measures to ensure safety in order to avoid any danger to people and property.

Failure to comply with these instructions may pose a danger to individuals.

Use the device only as specified in this manual; otherwise, the protection provided by the device may be compromised.



WARNING! Proper disposal

Ensure the proper disposal of the battery pack at the end of its life only through designated containers. This device *must not* be disposed of as household waste.

Follow the provisions of current national legislation.

2.0 SAFETY

Before using the Multigas Be Safe MG personal gas detector, it is very important to read and understand the Ex safety instructions provided in the quick guide that comes with the device, particularly the following sections:

- **Description**
- **Marking**
- **Instructions for safe use of the equipment - Par. 30.1 EN60079-0, Chapter 2**
- **Specific conditions for use**
- **Manufacturer's address**



WARNING!

This product can be considered a life-saving or injury-prevention safety device.

Incorrect use or maintenance of the device may compromise its proper functioning and, consequently, seriously endanger the life of the user.

Before use, it is necessary to check that the product is functioning correctly. The product must not be used if the Bump Test has failed, if there are any damages, or if maintenance/servicing has not been carried out by a Seitron authorized service center.

Any use that deviates from or is contrary to these instructions will be considered non-compliant. This applies particularly to unauthorized modifications to the product or repairs not carried out by a Seitron authorized service center.

2.1 Precautionary Safety Measures to Adopt

Bump Test

The frequency of the bump test is often regulated by national or company standards; however, as a general rule, performing a bump test before each use is the best safety practice and is therefore recommended by Seitron.

The Canadian Standards Association (CSA) requires the bump test procedure for the LEL sensor to be performed before daily use, using calibration gas concentrations between 25% and 50% LEL. The instrument must be recalibrated if, during a bump test, the reading does not fall between 100% and 120% of the expected value for the gas.

Before using the instrument, the device must pass the bump test.

If the bump test is not passed, DO NOT use the instrument; it is necessary to calibrate the sensors or send the instrument to a Seitron authorized service center.

Manually verify that the audible signal, visual, and vibrating alarms are activated.

Perform the bump test (see Chapter 10.5 "Bump Test") more frequently if the device has suffered physical shock or if it has been exposed to high levels of contaminants.

The bump test should also be performed more frequently if the tested atmosphere contains the following substances, which can reduce the sensitivity of the flammable gas sensor and lower the indicated values:

- Organic silicones
- Silicates
- Compounds containing lead
- Exposure to hydrogen sulfide concentrations above 200 ppm or exposure to more than 50 ppm for one minute.

Seitron recommends performing the bump test procedure (see Chapter 10.5 "Bump Test") before each use and advises charging the device's battery after every workday. Calibrate the device every 180 days.

Check the Minimum Concentration of Flammable Gas

The minimum concentration of flammable gas in the air that can ignite is defined as the Lower Explosive Limit (LEL).

The "XXX" flammable gas value indicates that the atmosphere exceeds 100% LEL or 5.00% vol CH₄, and there is a risk of explosion. Immediately leave the hazardous area.

Seitron recommends testing the combustible gas sensor with a known gas concentration after any exposure to contaminants/poisons such as sulfur compounds, silicone vapors, halogenated compounds, etc.

Pay Attention to the Atmosphere

Do not use the device to detect flammable or toxic gases in the following atmospheres, as the indicated values may be incorrect:

- Deficiency or excess of oxygen in the ambient air.
- Reducing atmospheres.
- Chimneys or furnace stacks.
- Inert atmospheres.
- Atmospheres containing volatile flammable mists or dust.

The device should only be used to detect gases/vapors for which a sensor has been installed.

The device is suitable and certified for measuring oxygen concentrations in gas mixtures for inerting, according to the EN 50104 standard, but without an alarm function.

Ensure that the oxygen level is >10% for accurate combustible readings with the catalytic sensor.

Sensor Maintenance

Do not obstruct the sensor openings to avoid inaccurate readings. To prevent damage and measurement errors, do not apply pressure to the front of the sensors. Do not use compressed air to clean the sensor openings, as the pressure may damage the sensors.

Adhere to Proper Stabilization Times

Allow sufficient time for the device to display a correct value. Reaction times vary based on the type of sensor used (See Chapter "4.0 Measurement Ranges and Sensor Accuracy").

Environmental Conditions Awareness

Gas sensor readings can be affected by various environmental factors, including changes in pressure, humidity, and temperature. Pressure and humidity variations affect the actual amount of oxygen in the atmosphere.

Pressure Variations

If the pressure changes rapidly (e.g., when passing through a pressurized chamber), the oxygen sensor reading may change momentarily and possibly trigger the device's alarm.

Humidity Variations

If humidity changes significantly (e.g., when moving from a dry, air-conditioned environment to outdoor air with high humidity), the oxygen readings may drop by up to 0.5% due to the displacement of oxygen by water vapor in the air. The oxygen sensor is equipped with a special filter that reduces the effects of humidity variations on oxygen readings. Its effect is not immediate but gradually influences oxygen readings over several hours.

Temperature Variations

The device has a built-in temperature compensation function. However, if the temperature changes rapidly, the sensor reading may vary.

To minimize the effect, zero the device at the working temperature.

If the device is used near its upper or lower operating temperature limit, Seitron recommends performing auto-zeroing or turning the device off and on in that environment.

Special Conditions for Safe Use

- In the event of an overrange condition for the flammable gas sensor, the device will enter Alarm Lock status, which must be reset in a fresh air environment. To reset this alarm, turn the device off and back on after moving to fresh air. Keep the device in fresh air until the LEL or CH₄ readings have stabilized, then follow the instructions for Fresh Air Setup and Zero Calibration contained in this manual.
- Prolonged exposure of the device to certain concentrations of combustible gases can strain the device's sensitive element and severely affect its performance. If an alarm is triggered due to a high concentration of combustible gas, the device calibration must be performed. If necessary, replace the sensor.
- High concentrations of certain toxic gases, such as H₂S, can damage the LEL sensor. This effect, known as inhibition, is usually temporary, but in extreme circumstances, it can impair the sensitivity of the LEL sensor after any exposure to gases that trigger alarms in toxic gas sensors.
- Protect the combustible sensor from exposure to lead compounds, silicones, and chlorinated hydrocarbons. While some organic vapors (such as leaded gasoline and halogenated hydrocarbons) can temporarily inhibit the sensor's performance, in most cases, the sensor recovers after calibration.
- High Off-Scale LEL Readings May Indicate an Explosive Concentration.
- Any rapid reading followed by a decreasing or erratic reading may indicate a gas concentration beyond the upper scale limit, which can be dangerous.
- The pellistors used in the catalytic flammable gas sensor may suffer from a loss of sensitivity in the presence of poisons or inhibitors, such as silicones, sulfides, chlorine, lead, or halogenated hydrocarbons.

- The device is equipped with an anti-static coating on the LCD display to minimize the risk of ignition due to electrostatic discharge. Periodic inspection of this coating is necessary to ensure it is free from degradation, delamination, abrasions, or other surface deformations.
- Care should be taken to avoid exposure to excessive heat, aggressive chemicals or solvents, sharp edges, and abrasive surfaces. Clean the exterior with a soft, damp cloth.
- The products may contain materials whose transportation is regulated under national and international dangerous goods regulations. Return the product in accordance with the appropriate dangerous goods regulations. Contact the goods carrier for further instructions.
- **Warning:** The lithium battery may present a fire or chemical burn hazard if misused; it should never be disassembled, incinerated, or heated above 100°C.
- **Warning:** Lithium polymer batteries exposed to high temperatures (above 130°C) for more than 10 minutes may cause fire and/or explosion.

3.0 TECHNICAL FEATURES

Power Supply:	Rechargeable internal Li-Ion battery 3.7 Vdc 2200 mA/h
Communication Port:	4 gold-plated brass contacts
Battery Charging Temperature:	10 °C to 30 °C
Charging Time:	<10 hours
Charging Indicator:	Red/green LED
Fully Charged Indicator:	Green LED + battery symbol on display
Alarms:	Audible Alarm: 90 dB @ 30 cm
	Vibration Alarm: Vibrating motor
	Visual Indicator: Steady green LED (Ok status)
	Visual Alarm: 3 flashing red LEDs
Display:	LCD display
Device Runtime:	Up to 18 hours
Ingress Protection:	IP67
Self-Diagnosis:	Full function and internal sensor check with error reporting
Autozero:	Automatic zero calibration cycle at startup (5 seconds - time not adjustable)
Internal Data Memory:	130,000 events automatically logged at 10-second intervals
Data Logging	64,320 logs (data saved every 10 seconds)

Operating Conditions

Usage:	Indoor and outdoor use
Temperature:	-20 °C to +55 °C
Humidity:	5% to 90% RH, non-condensing

Storage Conditions

Storage Temperature: -	20 °C to +55 °C
Humidity Limit:	5% to 90% RH

3.1 Dimensions



4.0 MEASUREMENT RANGES AND SENSOR ACCURACY

MEASUREMENT	MEASUREMENT RANGE	SENSOR TYPE	RESOLUTION	ACCURACY	RESPONSE TIME T90	POSITION
O ₂	0-25% Vol.	Electrochemical Lead free	0,1% Vol	±0,2% Vol	<10 sec	S1
CO	0-1000 ppm	Electrochemical	1ppm	±5 ppm	<15 sec	S2 - S3 - S4
NO	0 .. 250 ppm	Electrochemical	1ppm	±5 ppm	<30 sec	S2 - S3 - S4
NO ₂	0 .. 150 ppm	Electrochemical	1ppm	±2 ppm	<30 sec	S2 - S3 - S4
SO ₂	0 .. 100 ppm	Electrochemical	1ppm	±2 ppm	<20 sec	S2 - S3 - S4
H ₂	0 .. 1000 ppm	Electrochemical	1ppm	±5 ppm	<15 sec	S2 - S3 - S4
H ₂ S	0 .. 100 ppm	Electrochemical	0,1ppm	±0,5 ppm	<15 sec	S2 - S3 - S4
NH ₃	0 .. 100 ppm	Electrochemical	0,1ppm	±0,5 ppm	<15 sec	S2 - S3 - S4
CL ₂	0.. 20 ppm	Electrochemical	0,1ppm	±0,5ppm	<15 sec	S2 - S3 - S4
CO+H ₂ S (dual)	0 .. 1500ppm CO 0 .. 500ppm H2S	Electrochemical	1ppm	±5 ppm	<15 sec	S2 - S3 - S4
Flammable*	0-5% Vol. CH4	Catalytic (Pellistor)	1% LEL / 0,01% v/v	±5% LEL	<15 sec	S2
Flammable*	0-5% Vol. CH4	MEMS	1% LEL / 0,01% v/v	±5% LEL	<15 sec	S2

*: The instrument is by factory default with methane (CH4) as the combustible gas.

5.0 SENSOR POSITION



6.0 PRODUCT DESCRIPTION

6.1 Product code table

PM4	Personal Monitor with 4 Sensors	
Z	O2 sensor (Long Life)	S1 position
G	O2 sensor (Galvanic)	
X	Not sensor installed	
L	LEL sensor (VQ548MP2-DS)	S2 position
R	LEL sensor (4P75)	
X	Not sensor installed	
C	CO sensor	S3 position
H	H2S sensor	
B	NO2 sensor	
S	SO2 sensor	
Y	H2 sensor	
K	Cl2 sensor	
N	NO sensor	
X	Not sensor installed	
C	CO sensor	S4 position
H	H2S sensor	
B	NO2 sensor	
S	SO2 sensor	
Y	H2 sensor	
K	Cl2 sensor	
D	CO + H2S sensor (dual)	
X	Not sensor installed	
----	Non ATEX related characters	
SE	Branding Seitron	

6.2 General features

The personal monitor is equipped with:

- Electronic circuit which can host up to 4 sensors.
- LEDs, vibrating motor, and buzzer for alarm notifications.
- Belt clip.
- LCD display.
- Rechargeable Li-Ion battery pack.
- Two multifunction buttons.

6.3 Available software

- Be Safe MG Manager
PC Software compatible with Microsoft Windows 7 operative system or later, downloadable from the Microsoft Windows Store.

Features:

1. Displays the instrument's nameplate data.
2. Configures the instrument.
3. Performs the bump test.
4. Downloads the data stored during operation.

6.4 Calibration Certificate

A calibration certificate is included with the instrument.

6.5 MECHANICAL DESCRIPTION

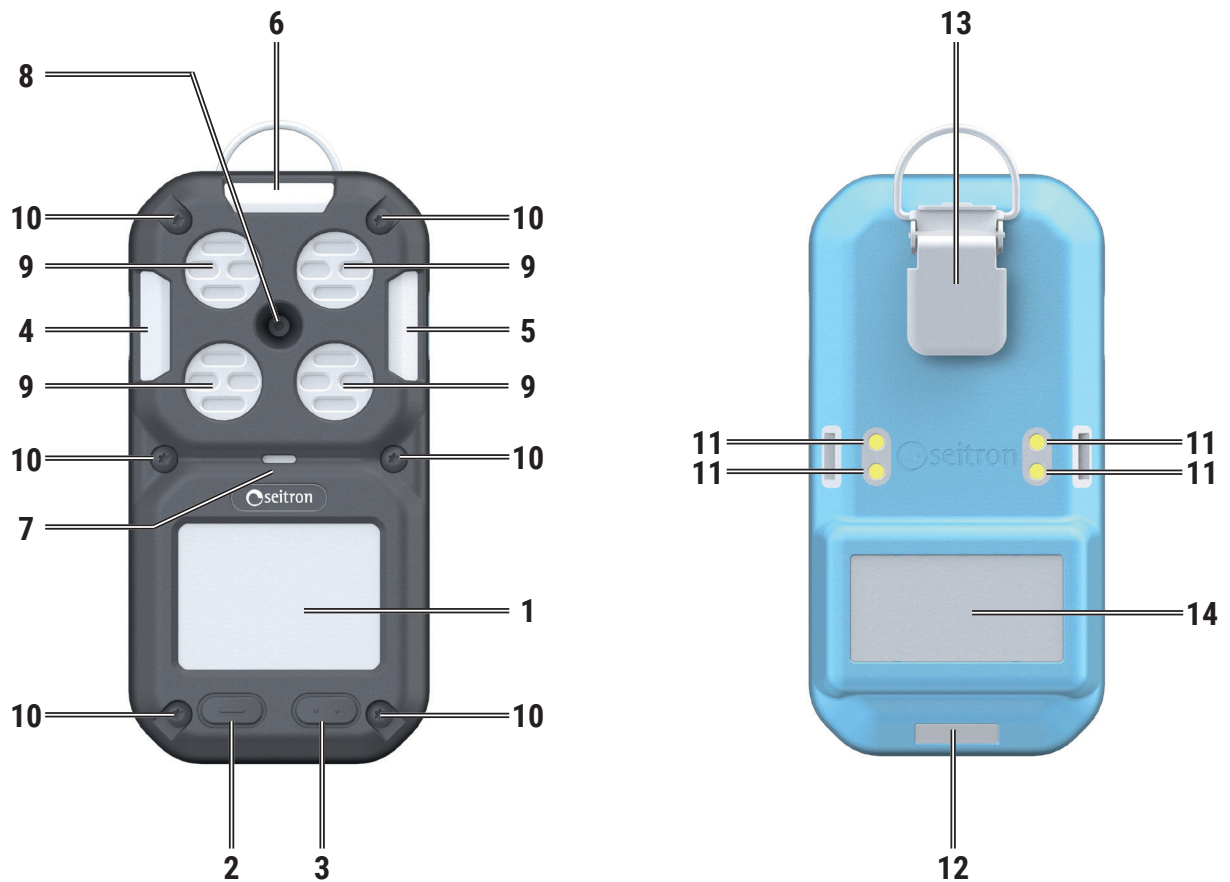



1	Display
2	Multifunction Button
3	Multifunction Button
4	Red LED: Alarm status indication
5	Red LED: Alarm status indication
6	Green LED: Normal operation indication ed LED: Alarm status indication
7	Red LED: Battery charging in progress Green LED: Battery charging completed (visible only if the battery is charged with the instrument turned off)
8	Buzzer
9	Sensor Openings
10	Screws (6 pieces) for shell closure
11	Contacts for battery charging and PC software communication
12	Serial Number
13	Belt Clip
14	Nameplate Data

6.6 Definition of Multifunction Buttons

The device is equipped with two operating buttons. Each button activates interactive functions indicated on the display directly above the button itself.

Below is the specific functionality of each button:





Button	Functions
 <p>Left Button</p>	<ul style="list-style-type: none"> - Power On: Long press turns the device on. - Power Off: In the measurement screen, the interactive function "OFF" appears; a long press turns off the instrument. <p>In General:</p> <ul style="list-style-type: none"> - Short Press: Activates the interactive arrow function. - Long Press: Activates interactive functions such as "ESC", "SETUP", "OK", etc.
 <p>Right Button</p>	<p>In General:</p> <ul style="list-style-type: none"> - Short Press: Activates the interactive arrow function. - Long Press: Activates interactive functions such as "ESC", "SETUP", "OK", etc..

6.7 LED Definition

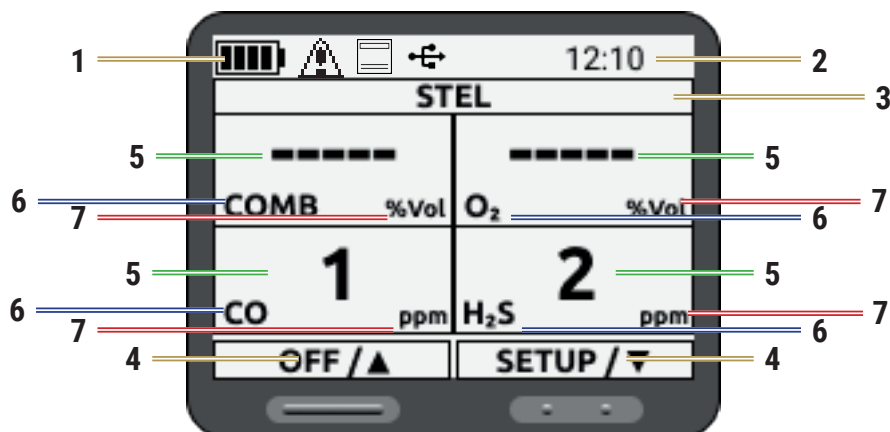
LED	Description
Red	- Indicates alarms or 'charging' status when the device is connected to the Docking Station and charging.
Green	- Indicates normal operation. Steady on.

6.8 Display icons and values setup



Reference	Description
1	<p>This part of the display shows several symbols:</p> <ul style="list-style-type: none">  Battery Charge Status (for further details see section 7.2.1 Battery maintenance.  The icon appears at startup if: <ul style="list-style-type: none"> 1. At least one sensor has reached the end of its life (EOL). 2. At least one sensor's calibration is expired and/or the last calibration failed. 3. During operation, the icon appears if a bump test fails; it remains until the instrument is turned off.  This symbol appears when the device is connected to the docking station, which is connected to the PC via USB cable, and the Be Safe MG Manager software is active. If the software is not active, the symbol briefly appears on the display.  This symbol appears when the instrument's logging function is active.
2	Shows current date and time in 12- or 24-hour format.
3	Displays the current screen being viewed.
4	This part of the display shows the instrument's interactive functions. To activate these functions, press the corresponding button below the indication.
5*	Value measured by the instrument.
6*	Gas being measured by the sensor.
7*	Displays the unit of measurement, or if the instrument is in alarm state, it indicates the type of alarm detected.

*: The display of this section may vary depending on the version of the instrument (while maintaining the data display mode) or when the user enters the instrument's menus.

6.9 Backlighting

The display backlighting is always on.

6.10 Vibration Alarm

The device is equipped with a vibration alarm.

6.11 Acoustic Alarm

The acoustic alarm provides an audible warning.

6.12 Visual Alarm

The visual alarm consists of flashing LEDs on the device.

6.13 Toxic Gas Monitoring

The device monitors the concentration of toxic gases in the ambient air. During normal operation, it displays the concentration of gases in parts per million (ppm) or mg/m³ on the measurement page.



WARNING!

If an alarm sounds during normal operation of the device, immediately leave the area. Remaining in the area under such circumstances exposes you to the risk of serious or fatal injuries.

For monitoring toxic gases, the device uses four alarms for each toxic gas:

- HIGH Alarm
- LOW Alarm
- STEL Alarm
- TWA Alarm

If the gas concentration reaches or exceeds the alarm threshold, the device will enter alarm mode (see Chapter 9.3 Alarms).

6.14 Oxygen Concentration Monitoring

The device monitors the oxygen concentration in the ambient air. Alarm threshold values can be set to activate under two conditions:

- Excess: Oxygen concentration > 23.5%
- Deficiency: Oxygen concentration < 19.5%



WARNING!

If an alarm sounds during normal operation of the device, immediately leave the area. Remaining in the area under such circumstances exposes you to the risk of serious or fatal injuries.

For monitoring oxygen levels, the device uses two alarms:

- HIGH Alarm
- LOW Alarm

If the gas concentration reaches or exceeds the alarm threshold, the device will enter alarm mode (see Chapter 9.3 Alarms).

Note:

Due to barometric pressure changes (altitude) or extreme ambient temperature variations, false oxygen alarms may occur. It is recommended to perform a zero calibration at the ambient temperature and pressure of use. Ensure that the device is in fresh air before proceeding with the zero calibration procedure, which is performed when the instrument is turned on. The device will remain in alarm mode until the oxygen concentration returns to the set levels.

6.15 Flammable Gas Monitoring

The device is capable of monitoring ambient air concentrations of methane and other flammable gases, which can be selected from the SETUP->Fuel menu.

The instrument displays the concentration of flammable gas in %Vol on the measurement page until another page is selected or the device is turned off.



WARNING!

If an alarm sounds during normal operation of the device, immediately leave the area. Remaining in the area under such circumstances exposes you to the risk of serious or fatal injuries.

For monitoring flammable gases, the device uses two alarms:

- HIGH Alarm
- LOW Alarm

If the gas concentration reaches or exceeds the alarm threshold, the device will enter alarm mode (see Chapter 8.3 Alarms).



WARNING!

A flammable gas reading of 100% LEL or 5.00% Vol CH₄ indicates a risk of explosion. Immediately leave the contaminated area.

6.16 Data Logging

To activate data logging, set the parameter SETUP -> Data logging to ON or OFF. When activated, the function records the gas levels detected by all sensors, with a maximum capacity of 15,000 records (approximately 40 hours with 10-second intervals).

All recorded data can be downloaded to a PC by installing the dedicated "Be Safe MG Manager" software.

The event logging function records significant events during the operation of the instrument. The event log can contain up to 15,000 events, including the following:

- LOW Alarm Activation
- HIGH (PEAK) Alarm Activation
- STEL Alarm Activation
- TWA Alarm Activation
- Calibration Events/Status
- Bump Test Events/Status
- Zero Calibration Events/Status
- Low Battery
- Faults

7.0 COMMISSIONING

7.1 Preliminary Operations

Remove the instrument from the packaging used for shipment and proceed with an initial inspection. Verify that the contents match what was ordered. If any signs of tampering or damage are noticed, immediately report the issue to the SEITRON Service Center or its representative, and retain the original packaging.

The serial number and model of the instrument are indicated on the instrument's nameplate.

It is recommended to provide both pieces of information for any technical assistance requests, spare parts, or technical and application clarifications.

Seitron maintains a record of the historical data for each instrument at its headquarters.

Before first use, it is recommended to perform a full battery charge cycle.

7.2 Battery Charging and Indications

The instrument is equipped with a rechargeable Li-Ion battery.



The display constantly shows the charge status of the internal battery, through the symbol located at the top left of the display.

 **WARNING!**
THE INSTRUMENT IS SHIPPED WITH A BATTERY CHARGE LEVEL NOT EXCEEDING 30%, AS REQUIRED BY CURRENT AIR TRANSPORT REGULATIONS.
BEFORE USE, PERFORM A FULL CHARGE CYCLE LASTING 6 HOURS.
IT IS RECOMMENDED TO CHARGE THE DEVICE AT AN AMBIENT TEMPERATURE BETWEEN 10°C AND 30°C.
IF THE INSTRUMENT IS NOT USED FOR AN EXTENDED PERIOD, IT IS ADVISABLE TO STORE IT AFTER A FULL CHARGE CYCLE AND RECHARGE IT AT LEAST ONCE EVERY 3 MONTHS.

The instrument can be stored for a period depending on the battery charge level; the table below specifies this time based on the charge level.

BATTERY CHARGE LEVEL	STORAGE DURATION
100%	120 days
75%	80 days
50%	45 days
25%	30 days

Battery charge status

SYMBOL	BATTERY STATUS
	5% charge remaining: The instrument battery has 30 minutes remaining; the instrument beeps twice (beep-beep).
	2% residual charge: Low battery alarm; instrument shuts down.

 **WARNING!**
If the battery warning or alarm goes off while you are using the device, leave the area immediately because the battery is running low.
Failure to heed this warning can result in serious or fatal injury.
As the battery ages, the useful life of the device is reduced.

Recharging batteries

To charge the instrument's battery, use only the AMDS01 charging station, provided with the instrument.

The charger can fully charge a completely discharged battery pack in less than six hours under normal conditions, at temperatures between 10°C and 30°C.



WARNING!

Explosion hazard: do not recharge the device in hazardous areas.

Using any charger other than the charger supplied with the device may damage or inadequately charge the batteries.



- The USB Type-C to Type-A cable is provided with the AMDS01; the Type-C connector must be connected to the charging station, while the Type-A connector must be connected to the PC or a 5 Vdc 500 mA charger.
- Ensure that the instrument is properly inserted into the charging cradle (you should hear the click of the side retaining clips).
- The red LED located at the center of the instrument will light up steadily in red. When the instrument is turned on, the number of segments inside the battery symbol increases progressively according to the charge percentage.
- Upon completing the charge:
 - When the instrument is off: the LED at the center of the instrument will light up in solid green.
 - When the instrument is on: the battery symbol will display all segments, but the red LED at the center of the instrument will remain illuminate
- During periods of non-use, the instrument can remain connected to the charging station.
- The minimum and maximum ambient temperatures for charging the device are 10°C and 30°C, respectively.
- For best results, charge the device at an ambient temperature of 23°C.

For more information on the charging station, communication, and Bump Test, AMDS01, refer to Appendix A of this manual.

7.3 Mounting the Bump Test / Calibration Adapter

The instrument comes with the AMGC01 adapter, which is used to perform the Bump Test and/or Calibration of the instrument.

Attach the left hook of the adapter into the transparent slot on the left side of the instrument (A).

Then, attach the right hook of the adapter into the transparent slot on the right side of the instrument (B) until you hear a click.

If no click is heard, the adapter is not securely attached to the instrument.



Refer to the relevant sections for detailed instructions on performing the Bump Test and Calibration.

After completing the Bump Test/Calibration, remove the cap, as it would prevent the gas from reaching the sensor during use.

7.4 Mounting the External Filter

The external filter AMAF01 is an optional accessory that contains filters allowing gas to pass through while protecting the sensors from dust and debris. The filter adapter protects the sensors, making instrument maintenance easier.

Attach the left hook of the adapter into the transparent slot on the left side of the instrument (A).

Then, attach the right hook of the adapter into the transparent slot on the right side of the instrument (B) until you hear a click.



The external filter can be used in hazardous areas.

It is designed to work with battery charging accessories, and there is no need to remove it when placing the instrument in the charging station.

The external filter must be replaced if the filters are damaged by substances like paint, grease, or oil, which could block the gas flow to the sensors.

8.0 OPERATION

8.1 Powering On/Off the Instrument

Powering On the Instrument

With the device turned off (OFF), press and hold the button indicated by the arrow.

The instrument will turn on and begin the startup process.

Powering Off the Instrument

With the device turned on (ON), press and hold the button indicated by the arrow as follows:

- On the measurement screen, the interactive function "OFF" will appear: hold down the button.
- From any other screen, switch to the measurement screen to turn off the instrument.



8.1.1 Startup Phase of the Instrument

During the startup of the device, the startup screens will appear in succession at 1-second intervals.

During the startup phase, the instrument displays the following screens:

Manufacturer's logo.
Device name.
Firmware version (FW) and serial number (SN) of the device
Date of the last successful calibration.



The operator's name currently using the device.

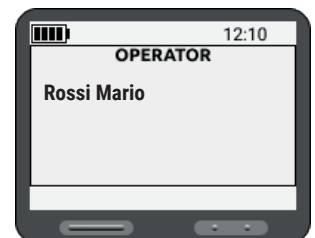

The gases detected by the instrument.
Refer to chapter "6.0 Product Description" to see the full list of measurements the instrument performs, with their abbreviations.

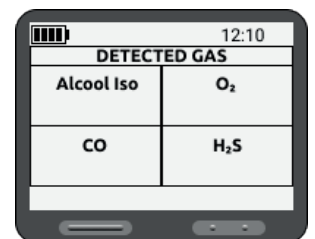

The measurement ranges of the sensors installed in the instrument are displayed.

Note: The units of measurement for toxic gases can be modified through the configuration menu.

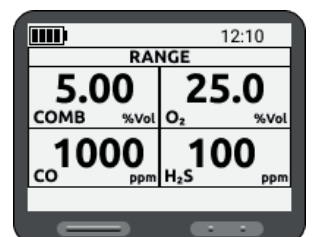

For each measured gas, the screen displays the "LOW ALARM" threshold.

Note: "LOW ALARM" thresholds can be manually adjusted through the configuration menu.

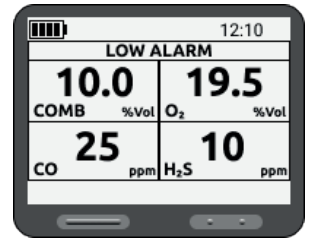

For each measured gas, the screen displays the "HIGH ALARM" threshold.

Note: "HIGH ALARM" thresholds can be manually adjusted through the configuration menu.

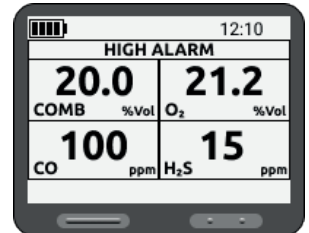

The "STEL" alarms (short-term exposure limit over 15 minutes) for each measured gas are displayed.

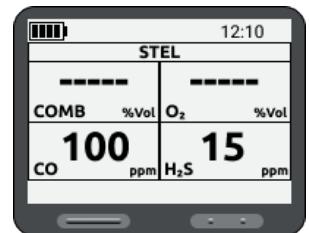

The "TWA" alarms (time-weighted average since the first use or since the memory values were reset) for each measured gas are displayed.

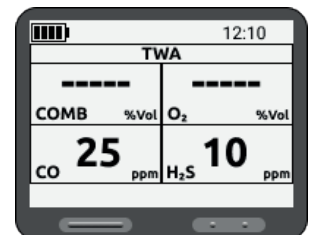

Peak values for each measured gas, recorded since the first use or the last reset, are displayed.

Press **Reset** to clear the stored peak values.

Press **Ok** to confirm and continue.

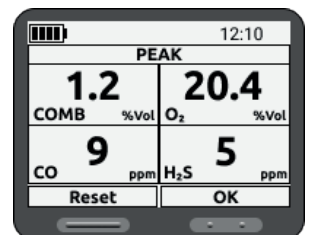

The calibration status of the device's sensors is shown.

The date refers to the last valid calibration.

If a "*" appears next to the date, it means less than 30 days remain until calibration expires.

If the expiration date has passed, the symbol "⚠" will appear, and the date will be replaced by "**".

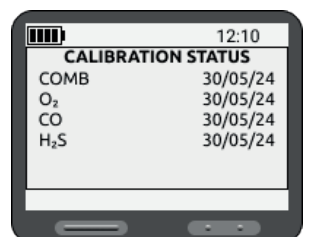

This screen shows the status of Bump Tests and the date of the last Bump Test performed.

Press the button for the interactive function "Ok" to confirm reading the message. On first startup, all sensors will show an empty date field (--/--/--) indicating that the Bump Test must be performed.

If the Bump Test has not been performed or has failed for one or more sensors, the "▲" symbol will appear and the buzzer activates intermittently.

In this case, pressing **Ok** allows the instrument to continue, but the "▲" symbol remains until the Bump Test is completed.

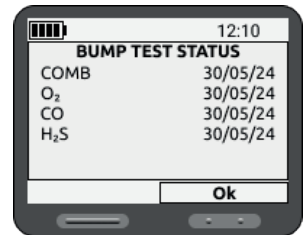

If the instrument was turned off for less than 15 minutes, on restart, the user will be prompted whether to retain the cumulative averages for STEL (Short-Term Exposure Limit) and TWA (Time-Weighted Average) alarms.

Retaining these averages ensures continuous and accurate monitoring of toxic gas exposure.



Place the instrument in clean air and press the button for the interactive function "Ok" to start the instrument's auto-zeroing process.

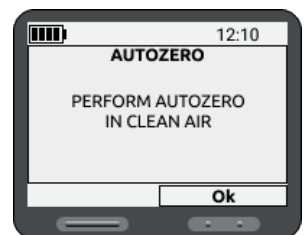

If the auto-zero fails for one or more sensors, ensure the instrument is in clean air and press **ESC** to restart the auto-zero process; If the auto-zero is successful, press **ESC**.

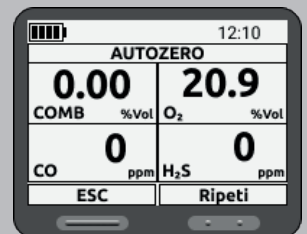

When auto-zeroing is complete, the normal operating screen will appear, displaying the real-time measurements of the instrument.

Two interactive functions are present:

OFF/▲: Holding for 5 seconds will turn off the instrument.

A short press cycles through the current values:

"PEAK" - "STEL" - "TWA" - "MEASURE"

SETUP/▼: Long press (5s) access the instrument configuration menu.

Short press cycles through the current values of:

"PEAK" - "STEL" - "TWA" - "MEASURE"

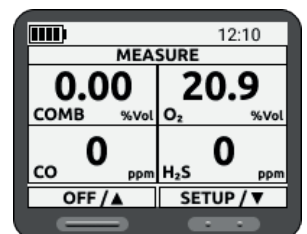

The peak values for each measured gas, recorded since the first use or since the values in memory were reset, are displayed.

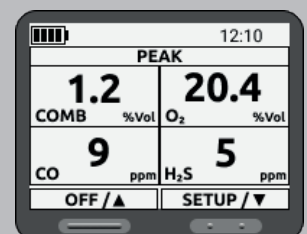

The "STEL" values (short-term exposure limit) calculated by the device, representing the average exposure over a 15-minute period, are displayed for each measured gas.

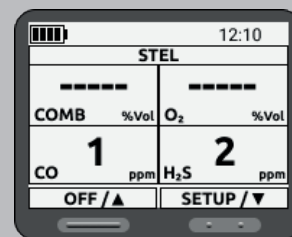

The "TWA" values (time-weighted average), which represent the average exposure from the first use of the device or since the last reset of the values in memory, are also shown for each gas.

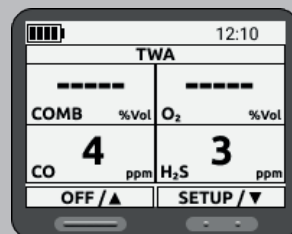

8.1.2 Minimum instrument configuration

After the device startup phase is finished, at least the following parameters need to be set:

- Fuel:** If the instrument uses combustible gas sensors, it is necessary to configure the type of gas to be detected.
- Alarms:** Set the alarm thresholds (minimum alarm, maximum alarm, STEL, TWA) if you wish to modify them from the factory settings.
- Clock:** Set the current date and time.
- Language:** Set the language.
- Operator:** Set the operator's details who will use the instrument (this can only be done via PC).

To set the parameters:

From PC: Use the "**Be Safe MG Manager**" software, which can be downloaded from the Microsoft Store (recommended). Connect via the AMDS01 charging and communication station provided with the instrument.

Directly from the instrument: Press and hold the button for the "SETUP/▼" interactive function.

8.2 Autozero

Auto-zero is performed by the instrument during the initial power-up phase. If you want to perform auto-zero during normal operation, you must turn the instrument off and then back on.

The auto-zero process is used to detect the zero point of the installed gas sensors. It only occurs within specific limits. If any sensor is outside these limits, the display will show "ERROR," and measurements for that sensor will be suspended.

In case of an error, repeat the auto-zero procedure while ensuring you are in clean air. If the error persists, proceed with calibrating the sensors that generated the error.



WARNING!

Do not activate the auto-zero function unless you are certain that the surrounding air is pure and uncontaminated; otherwise, inaccurate readings may occur, incorrectly indicating a hazardous atmosphere as safe.

If you have any doubts about the air quality, do not use the auto-zero function.

If the battery charging cycle is interrupted before completion (when starting from a fully discharged battery, at least 4 hours of charging is required), wait for 30 minutes to allow the internal temperature of the device to stabilize before performing the auto-zero.

8.3 Alarms

Below are the alarm types and the behavior of the device when an alarm condition is detected. The device will automatically return to normal operation once the alarm condition is resolved. To modify alarm thresholds, refer to the "Alarms" configuration menu.

 **WARNING!**

If one or more alarms are triggered, immediately leave the contaminated area; the gas concentration in the environment has reached the preset alarm threshold

Failure to follow this warning can result in excessive exposure to toxic gases, which may lead to serious or fatal injuries for those relying on this product for their safety.

The alarm will stop if the measured value falls below the preset alarm threshold.

To silence the alarm, the device must be turned off.

STEL and TWA alarms are specific to toxic gas sensors only.

LOW and HIGH alarms can be set for all sensors.

Alarms are disabled if set to zero or if the device is in CALIBRATION mode or connected to a PC.

Prioritization of alarms

- The High Alarm (HIGH or PEAK) and the STEL Alarm have the same priority.
- High Alarms (or PEAK) and/or STEL Alarms take precedence over Low Alarms (LOW ALARM) and TWA Alarms.
- The vibration alarm is disabled at -20°C.

Allarme basso

When the set threshold is exceeded, the instrument goes into alarm status:

- Acoustic signal activated.
- Vibration activated.
- Flashing "Low" appears instead of the unit of measurement of the sensor that detected the alarm.
- The measurement flashes and continues to update.

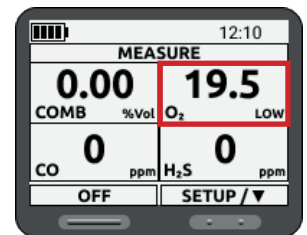

High alarm

When the set threshold is exceeded, the instrument goes into alarm status:

- Acoustic signal activated.
- Vibration activated.
- Flashing "HIGH" appears instead of the unit of measurement of the sensor that detected the alarm.
- The measurement flashes and continues to update.

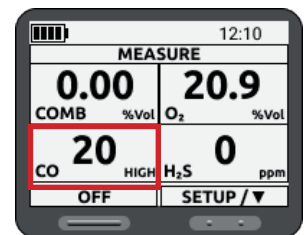

TWA Alarm (Time Weighted Average)

The screen displays the TWA icon indicating the average exposure since the device was turned on.

When the detected gas quantity exceeds the 8-hour TWA limit:

- An audible alarm is activated.
- The vibration alarm is activated.
- The "TWA" indicator flashes in place of the sensor unit of measure that triggered the alarm.
- The value flashes and continues to update.

The averaged values are used to calculate the TWA, the counting of which starts from the time the instrument is turned on or from reset and the result is related to an 8-hour exposure day.

Examples of TWA threshold calculation:

Assume that the device has been working for at least 15 minutes.

One-hour exposure to 50 ppm:

$$\frac{(1 \text{ hour} \times 50 \text{ ppm}) + (7 \text{ hour} \times 0 \text{ ppm})}{8 \text{ hours}} = 6,25 \text{ ppm}$$

4-hour exposure at 50 ppm and 4-hour exposure at 100 ppm:

$$\frac{(4 \text{ hours} \times 50 \text{ ppm}) + (4 \text{ hours} \times 100 \text{ ppm})}{8 \text{ hours}} = 75 \text{ ppm}$$

12-hour exposure at 100 ppm:

$$\frac{(12 \text{ hours} \times 100 \text{ ppm})}{8 \text{ hours}} = 150 \text{ ppm}$$

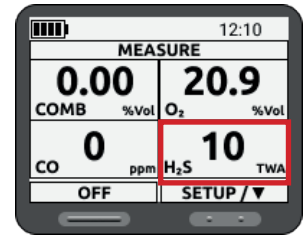

STEL alarm (Short Term Exposure Limits)

The STEL alarm indicates the average exposure over a 15-minute time frame.

When the amount of gas detected by the device exceeds the set STEL threshold:

- Acoustic signal activated.
- Vibration activated.
- A flashing "STEL" appears instead of the unit of measurement of the sensor that detected the alarm.
- The value flashes and continues to update.

The value for the STEL alarm is calculated during a 15-minute exposure.

Examples of STEL threshold calculation:

Assume that the device has been working for at least 15 minutes.

15-minute exposure at 35 ppm:

$$\frac{(15 \text{ minutes} \times 35 \text{ ppm})}{15 \text{ minutes}} = 35 \text{ ppm}$$

10-minute exposure at 35 ppm and 5-minute exposure at 5 ppm:

$$\frac{(10 \text{ minutes} \times 35 \text{ ppm}) + (5 \text{ minutes} \times 5 \text{ ppm})}{15 \text{ minutes}} = 25 \text{ ppm}$$

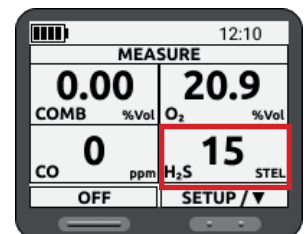

Sensor end of life (EOL)

- **Position Indication:** SETUP -> Diagnostic -> Sensors. At the end-of-life date, the sensor is still functional; this allows the sensor to be scheduled for replacement in time.
- Warning Icon :
- Less than 30 days: warning icon appears.
 - Upon expiration: "Expired/expired" appears next to EOL.
- **'AbsLifeT' Indication:**
 - Less than 30 days: 'AbsLifeT' followed by '*', eg. "AbsLifeT 1440 dd *".
 - Expired: 'AbsLifeT' followed by '**', es. "AbsLifeT 1470 dd **".

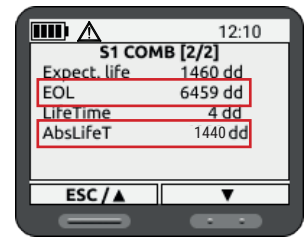

Normal operation indication:

The instrument shows the current measurements of the gases detected.

Note

If the device detects any alarm condition, alarm reports take priority.

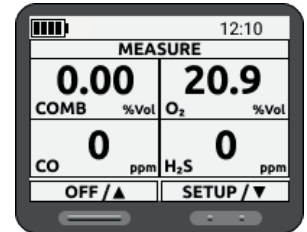

9.0 BUMP TEST

When you have finished configuring the minimum parameters for using the instrument (see section 8.1.2 Minimum Instrument Configuration), you need to perform the Bump Test.

A bump test is a gas test that involves verifying that the known and certified gas concentration provided to the device is correctly detected by the sensors. The BUMP TEST must be performed for each installed sensor.

If the bump test fails, proceed with the calibration of the sensors.



WARNING!

As required by the EN60079-29 Part 1 standard, portable devices that detect flammable gases must undergo a functional check with gas before each day of use.

Depending on local circumstances, other testing systems may be adopted.

If the BUMP TEST is not successfully passed, it is necessary to proceed with the calibration of the sensors or send the device to an authorized Seitron service center.

It is possible to perform the BUMP TEST using the procedure described below.

CSA requires (for 22.2 NO. 152) to check the sensitivity of the flammable gas sensor against a known concentration of methane before daily use, equivalent to 25 - 50% of the full scale concentration.

THE ACCURACY MUST BE WITHIN 0 TO +20% OF THE ACTUAL VALUE.

The following tools and equipment are needed to perform the Bump Test:

- **Mixture of calibrated gas** suitable for the sensors to be tested with a known gas concentration; the cylinder must be equipped with a pressure regulator set to 0.5 liters/min. See section 9.2 Setting the menu 'Setup cal gas'.
- **Transparent Raucclair tube 4x7mm, 0.5 meter length, supplied with the instrument.**
- **Calibration cap, supplied with the instrument.**

The Bump Test can be performed directly on the instrument via the appropriate menus or via PC, after installing the "Be Safe MG Manager" software that can be downloaded from the website www.seitron.com, through the use of the AMDS01 charging and communication station, supplied with the instrument.

9.1 Connecting the instrument to the cylinder

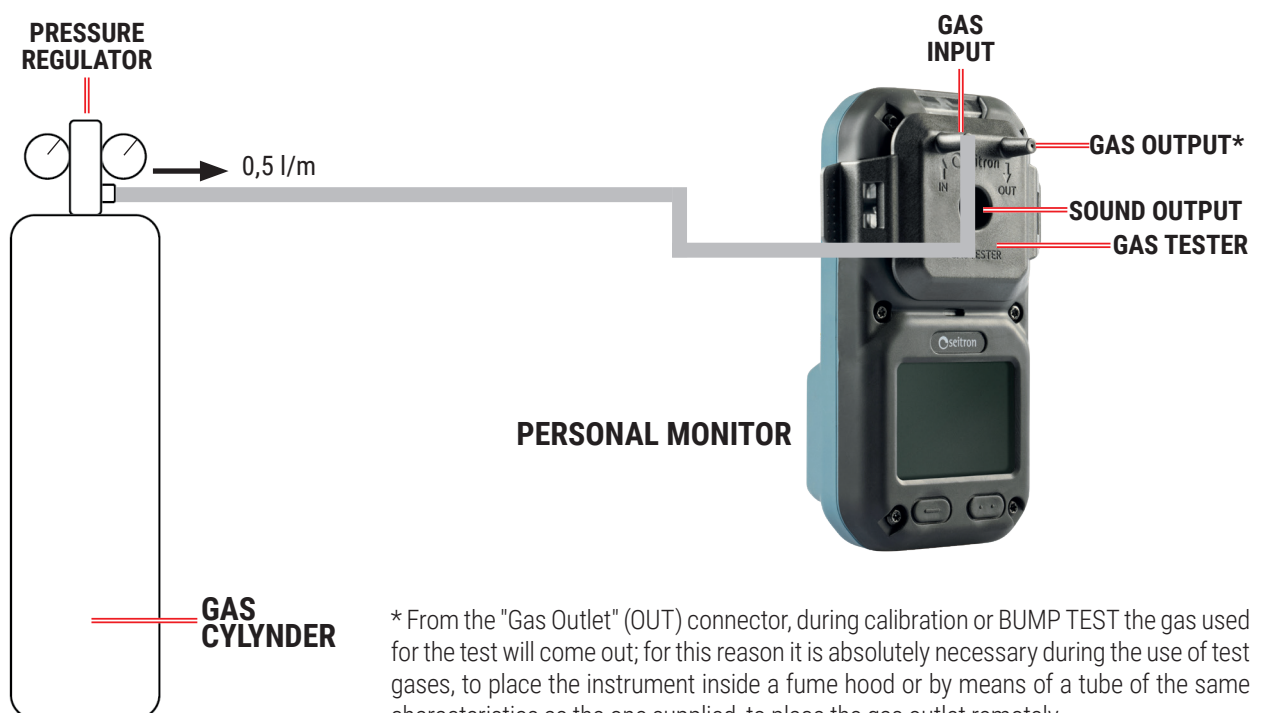

* From the "Gas Outlet" (OUT) connector, during calibration or BUMP TEST the gas used for the test will come out; for this reason it is absolutely necessary during the use of test gases, to place the instrument inside a fume hood or by means of a tube of the same characteristics as the one supplied, to place the gas outlet remotely.

9.2 Menu setting "Bump Test Cylinder Conc."

This menu sets the gas concentrations corresponding to the gas cylinders used to perform the BUMP TEST.

- **For performing the gas sensor Bump Test, Seitron recommends using calibrated gas mixtures with concentrations defined in the following table.**
- **Do not use the gas cylinder beyond its expiration date.**

The following table provides information on the sensors and the corresponding gas mixtures required for performing the Bump test.

SENSOR: The sensor installed on the instrument on which it is required to perform the Bump test.

GAS MIX / GAS CONCENTRATION: Gas Mix to be used for Bump test performance.

SENSOR	GAS MIX / GAS CONCENTRATION
H2S + COMB + O2 + CO (*)	H2S 25 ppm + CH4 2,2% Vol. + O2 18% Vol. + CO 50 ppm + N2
CL2	CL2 10 ppm + N2
H2	H2 200 ppm + Aria
S02	S02 20 ppm + N2
NO2	NO2 10 ppm + N2
NO	NO 50 ppm + N2
NH3	NH3 50 ppm + Aria

(*) The bump test can be carried out simultaneously for all sensors.

The procedure for entering the gas concentrations to be used during the execution of the Bump Test from the device is described below.

It is possible to access the device menu only when the instrument displays the measurement screen. By holding the button related to the interactive function "SETUP/▼" for at least 5 seconds, you can access the device menus; then select the 'Bump Test bottle cnc.' menu and proceed as described in the following example screens.

The adjacent screen shows an example where the gas concentrations to be used during the execution of the Bump Test are visible.

These concentrations must match the gas concentrations of the cylinders used during the test.

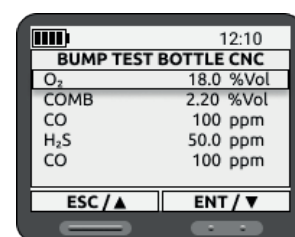

Briefly press one of the two buttons to select the test gas for which you want to change the concentration.

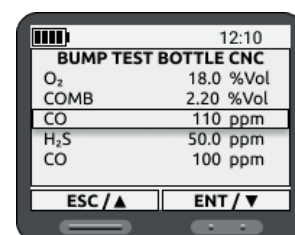

Press and hold the right button related to the interactive function "ENT/▼" to enter edit mode (example referring to CO gas).

You can modify the value of each digit one at a time.

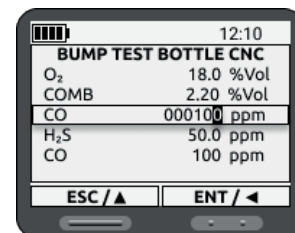

Briefly press the button related to the interactive function "ENT/◀" to enter the digit to change.

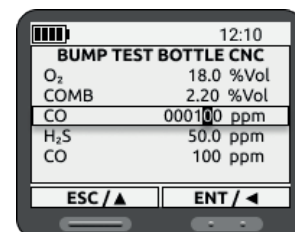

Briefly press the button related to the interactive function "ESC/▲" to change the value.

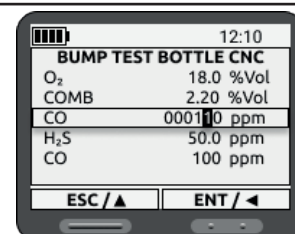

Press and hold the right button corresponding to the interactive function "ENT/◀" to confirm the modified single digit. Conversely, press and hold the left button corresponding to the interactive function "ESC/▲" to cancel the modification and return to the previous action.

Proceed as described above to modify the other digits.

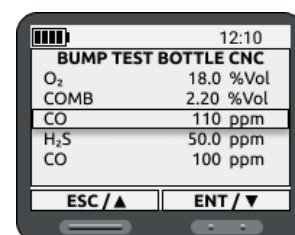

Proceed as described so far to configure the other gas concentrations.

Otherwise, press and hold the left button corresponding to the interactive function "ESC/▲" again to exit the menu.

9.3 Performing a Bump Test

Instrument Preparation

Before performing the Bump Test, it is necessary to carry out the autozero.

Therefore, turn the instrument off and back on.

Wait for the startup phase to complete.

WARNING

- Ensure that the autozero is performed in clean air and completes successfully.
- Check that the battery charge level is at 100%.

It is recommended to perform the Bump Test with the instrument placed in the charging station and connected to the power supply.

Starting the Bump Test from the Instrument

The following describes the procedure for performing the Bump Test from the instrument.

You can access the device menu only when the instrument displays the measurement screen.

By holding down the button corresponding to the interactive function "SETUP/▼" for at least 5 seconds, you can access the instrument menus; then proceed as described in the following example screens.

Verify, through the "BUMP TEST CHIL. CONC" menu, that the gas concentrations set match those indicated on the gas cylinder you will use for the Bump Test.

If not, set the values using the "BUMP TEST CHIL. CONC" menu.

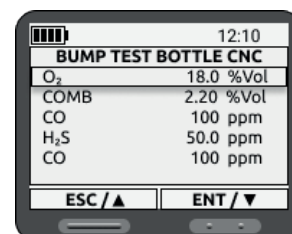

BUMP TEST BOTTLE CNC	
O ₂	18.0 %Vol
COMB	2.20 %Vol
CO	100 ppm
H ₂ S	50.0 ppm
CO	100 ppm

Select the "BUMP TEST" menu.

The instrument will offer to perform the Bump Test **simultaneously on all sensors** (Gas mixture) **or for each individual gas** (Single gas).

Select the Bump Test mode by briefly pressing the buttons for the interactive functions "ESC/▲" or "ENT/▼".

Once the Bump Test mode is selected, press and hold the button for the interactive function "ENT/▼".



BUMP TEST	
Single gas	
Gas mixture	

WARNING

Performing the Bump Test simultaneously on all installed sensors is only available if the instrument is configured with the following 4 sensors:

O₂ - CO - H₂S - L.E.L.

When performing the Bump Test simultaneously on all installed sensors, use a cylinder containing all the gases corresponding to the sensors installed on the instrument.

Bump Test "Gas mixture"

If "Gas mixture" is selected, press and hold the right button for the interactive function "ENT/▼".

At this point, the instrument will prompt you to apply the gas.

Once the gas is applied to the instrument, press and hold the right button for the interactive function "ENT" to start the BUMP TEST.

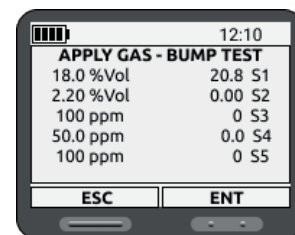

The instrument will display the screen on the side; the test duration is 30 seconds.

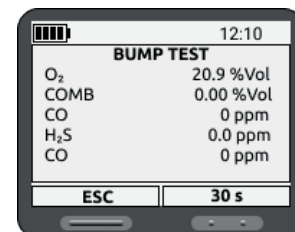

The Bump Test is considered complete within 30 seconds, or when the detector displays the applied gas concentration.

Note: During the Bump Test, it is normal for the instrument to activate the respective alarms when it detects concentrations at the LOW and HIGH alarm thresholds.

After the Bump Test is complete, stop the gas flow and remove the cap. Then, place the instrument in fresh air. The alarms will automatically reset as the gas concentration decreases.

The alarm log will be automatically stored in the detector.

The device will indicate next to the sensor whether the test was passed with the following messages:

“✓” “BUMP TEST PASSED”

“✗” “ERROR - BUMP TEST FAILED”

In case of an error, the symbol “⚠” will appear on the top status bar. In this case, press the right button for the interactive function “ESC”.

Verify that the gas is reaching the instrument correctly and that the applied gas concentrations match those configured in the “BUMP TEST CHIL. CONC” menu.

Then, repeat the Bump Test.

If the Bump Test does not pass, proceed with the calibration of the gas sensors.

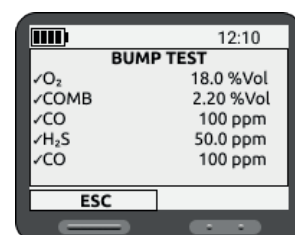

Bump Test Single gas

If "Single Gas" is selected, press and hold the right button for the interactive function "ENT/▼".

Select the gas sensor for the Bump Test, then press and hold the right button for the interactive function "ENT/▼".

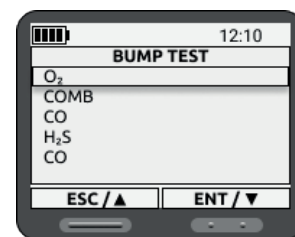

At this point, the instrument will prompt you to apply the gas.

Once the gas is applied to the instrument, press and hold the right button for the interactive function "ENT" to start the BUMP TEST (example refers to the O2 gas).

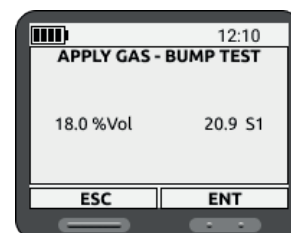

The instrument will display the screen on the side; the test duration is 30 seconds.

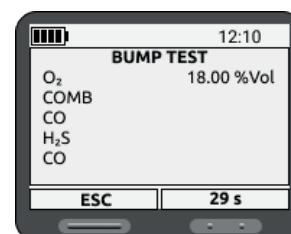

The Bump Test is considered complete within 30 seconds, or when the detector displays the applied gas concentration.

Note: During the Bump Test, it is normal for the instrument to activate the respective alarms when it detects concentrations at the LOW and HIGH alarm thresholds.

After the Bump Test is complete, stop the gas flow and remove the cap.

Then, place the instrument in fresh air. The alarms will automatically reset as the gas concentration decreases/increases. The alarm log will be automatically stored in the detector

The device will indicate next to the sensor whether the test was passed with the following messages:

“✓” “BUMP TEST PASSED”

“✗” “ERROR - BUMP TEST FAILED”

In case of an error, the symbol “⚠” will appear on the top status bar. In this case, press the right button for the interactive function “ESC”.

Verify that the gas is reaching the instrument correctly and that the applied gas concentration matches what is configured in the “BUMP TEST CHIL. CONC” menu.

Then, repeat the Bump Test.

If the Bump Test does not pass, proceed with the calibration of the gas sensor.

Follow the above instructions to perform the BUMP TEST on the other installed gas sensors.

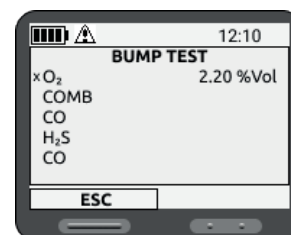
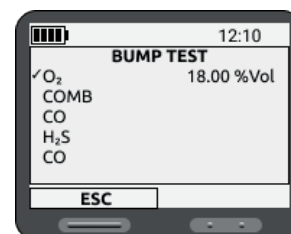

Proceed as described so far to perform the BUMP TEST on the other installed gas sensors.

10.0 CALIBRATION OF THE SENSORS

Calibration allows the sensors to be realigned to ensure proper functioning and accuracy of the device readings.

The factory setting for the Be Safe MG requires the calibration of the detector every 30 days.

In any case, gas sensor calibration is necessary whenever the Bump Test result is negative.

The gas sensor calibration menu is password-protected. The instrument leaves the factory with the password set to **0000**.

If calibration fails, contact the Seitron service center.



WARNING!

- Before starting the Calibration procedure, ensure that the device is not in an alarm or fault state.
- Check and resolve any alarms or faults before proceeding with calibration.
- At altitudes above 2,000 meters, calibration may result in lower readings; calibration performed at high altitudes may lead to less accurate or underestimated readings compared to conditions at lower altitudes. This is important to consider because altitude can affect the properties of gases and, consequently, the effectiveness of calibration.

To perform calibration, the following tools and equipment are required:

- **Zero gas calibration mixture:**

Ambient air

- **Span gas calibration mixture**

A certified gas mixture suitable for the sensors to be tested, with a known gas concentration; the cylinder must be equipped with a pressure regulator set to 0.5 liters/min. See the paragraph "10.2 Setting up the 'Setup cal gas' menu."

- **Transparent Raucclair tube 4x7mm, 1/2 meter long, provided with the instrument.**

- **Calibration cap, provided with the instrument.**

The calibration of the sensors can be performed directly on the instrument through the appropriate menus or via PC, after installing the "Be Safe MG Manager" software, available for download from the website www.seitron.com, using the AMDS01 charging and communication station, provided with the instrument.

10.1 Connecting the instrument to the cylinder

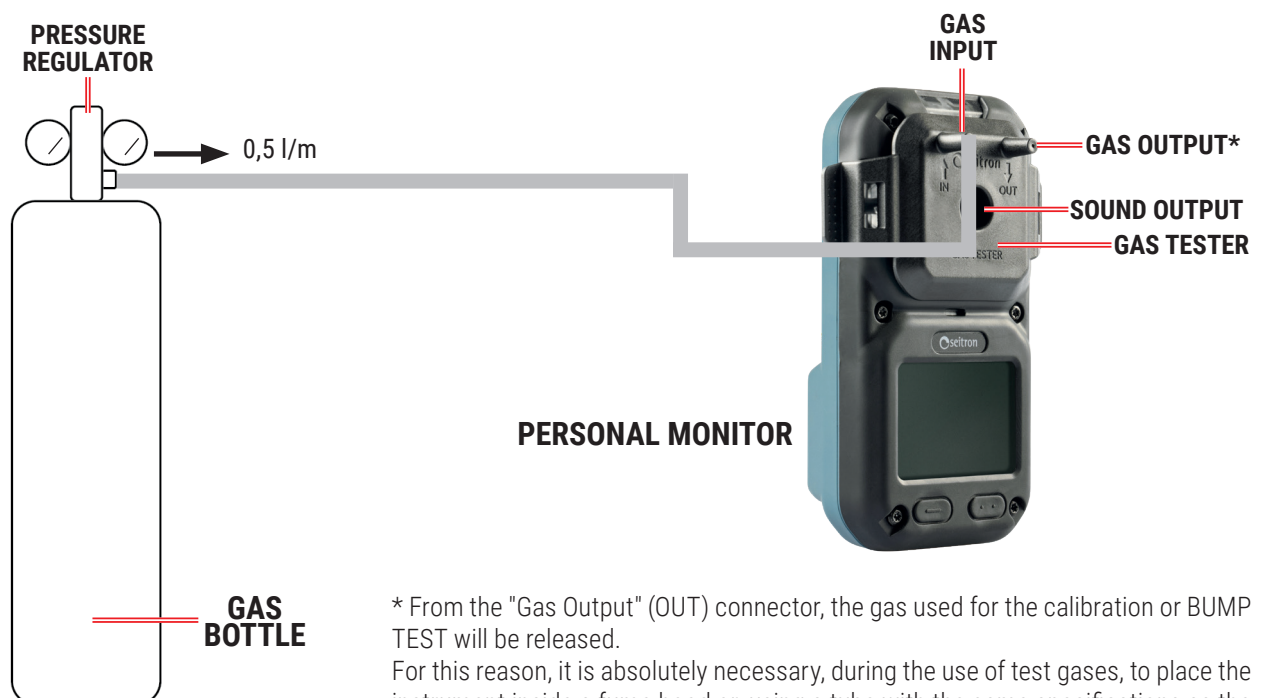

* From the "Gas Output" (OUT) connector, the gas used for the calibration or BUMP TEST will be released.

For this reason, it is absolutely necessary, during the use of test gases, to place the instrument inside a fume hood or, using a tube with the same specifications as the one provided, direct the gas output remotely.

10.2 Setting up the "Setup cal gas" Menu

In this menu, you set the gas concentrations corresponding to the gas cylinders used for the Span gas calibration of the sensors installed on the instrument.

- **For Span gas calibration, Seitron recommends using certified gas mixtures whose concentration is defined in the table in paragraph 9.2, "Bump Test Cylinder Conc." Menu Settings.**
- **Do not use the gas cylinder beyond its expiration date.**

The procedure for entering the gas concentrations to be used during the Span gas calibration of the gas sensors is described below.

You can access the device menu only when the instrument displays the measurement screen.

By holding down the button for at least 5 seconds for the interactive function "SETUP/▼" you access the instrument menus. Then, select the "Setup cal gas" menu and proceed as described in the following example screens.

The "Gas cal setup" menu is password-protected.

The instrument leaves the factory with the password set to "0000".

Press and hold the button for the interactive function "ENT/▼" to access the menu.



The screen on the side shows an example where the gas concentrations to be used during the Span calibration are visible.

These concentrations must correspond to the gas concentrations in the cylinders used for the test.

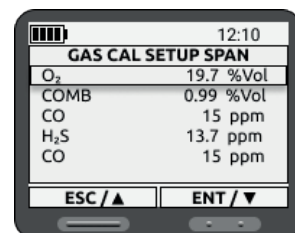

Briefly press either of the two buttons to select the test gas for which you want to change the concentration.

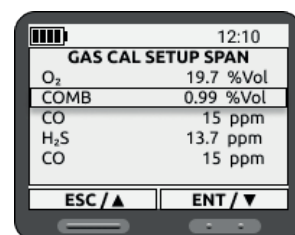

Press and hold the right button for the interactive function "ENT/▼" to enter edit mode (example refers to CO gas).

You can modify one digit of the value at a time.

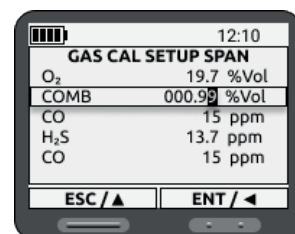

Briefly press the button for the interactive function "ENT/◀" to select the digit to be changed.

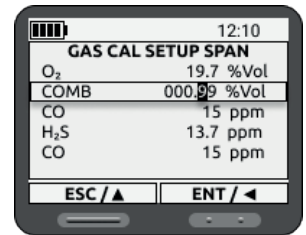

Briefly press the button for the interactive function "ESC/▲" to change the value.

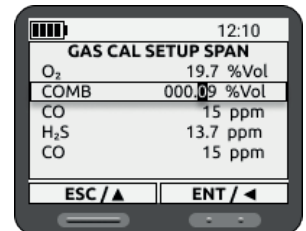

Press and hold the right button for the interactive function "ENT/◀" to confirm the modified digit.

Conversely, press and hold the left button for the interactive function "ESC/▲" to cancel the modification and return to the previous action.

Proceed as described above to modify the other digits.

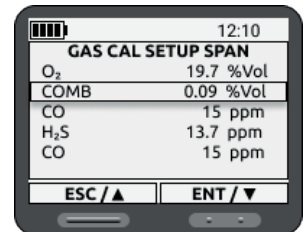

Follow the instructions given so far to configure the other gas concentrations.

Otherwise, press and hold the left button for the interactive function "ESC/▲" again to exit the menu.

10.3 Calibration Procedure

Instrument Preparation

Before proceeding with the Calibration, it is necessary to perform an autozero. Therefore, turn off the instrument and turn it back on.

Wait for the startup phase to complete.

WARNING

- Ensure that the autozero is performed in clean air and completes successfully.
- Check that the battery is fully charged to 100%.
It is also recommended to perform the Calibration with the instrument inserted in the battery charging station and connected to the power supply.
- During Calibration, all alarm signals are disabled.

Starting the Calibration

Below is the procedure for performing Calibration from the instrument.

You can access the device menu only when the instrument displays the measurement screen. By holding down the button for at least 5 seconds for the interactive function "SETUP/▼" menus. Then, proceed as described in the following example screens.

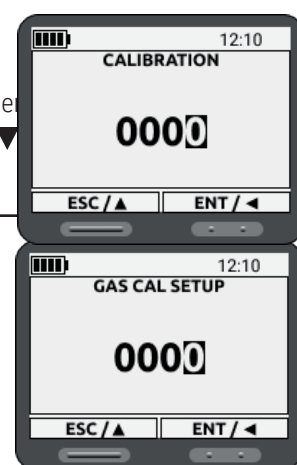

Verify, through the "GAS CAL SETUP" menu, that the gas concentrations set match those indicated on the gas cylinder you will use for the Calibration. If not, set the values correctly.

Select the "CALIBRATION" menu.

The "CALIBRATION" menu is password-protected.

The instrument leaves the factory with the password set to "0000".

Press and hold the button for the interactive function "ENT/▼" to access the menu.

The instrument will offer to perform the Calibration **simultaneously on all sensors** (Gas mixture) or for **each individual gas** (Single gas).

Select the Calibration mode by briefly pressing the buttons for the interactive functions "ESC/▲" or "ENT/▼".

Once the Calibration mode is selected, press and hold the button for the interactive function "ENT/▼".

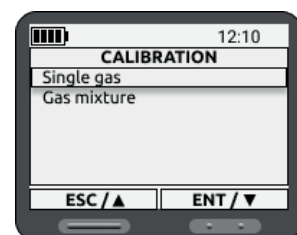

WARNING

Performing Calibration simultaneously on all installed sensors is only available if the instrument is configured with the following 4 sensors:

O2 - CO - H2S - L.E.L.

When performing Span gas Calibration simultaneously on all installed sensors, use a cylinder containing all the certified gases corresponding to the sensors installed on the instrument.

"Gas mixture" calibration

Zero Calibration

Select "ZERO Calibration", then press and hold the right button for the interactive function "ENT/▼".



At this point, the instrument will prompt you to apply the gas
Provide clean air to the instrument and press and hold the right button for the interactive function "ENT" to start the Zero Air Calibration.

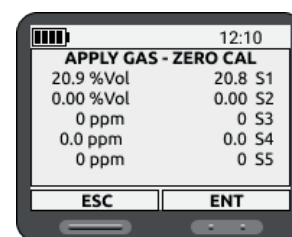

The instrument displays the screen shown on the side; the test lasts for 30 seconds.

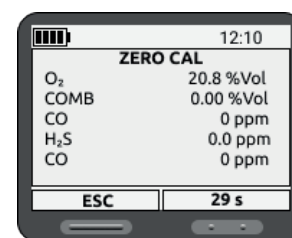

Within 30 seconds, the Zero Air Calibration is complete when the detector displays the screen shown on the side.

The device shows the status of the Zero Calibration next to the sensor with the following indication:

"✓" "Zero Calibration PASSED" - Proceed with Span Gas Calibration.

"✗" "ERROR - Zero Calibration NOT PASSED"

In case of an error, the symbol "⚠" will appear on the status bar at the top. In this case, press the right button for the interactive function "ESC".

Verify that clean air is reaching the sensors correctly.

Then, repeat the Zero Calibration.

If the Zero Calibration fails, the problematic sensor must be replaced; contact the Seitron service center.

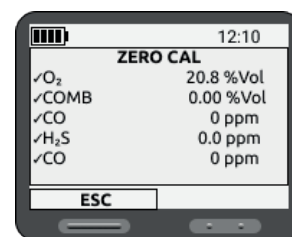

Span Calibration

Select "SPAN Calibration", then press and hold the right button for the interactive function "ENT/▼".

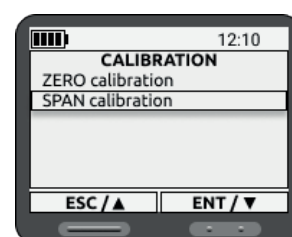

At this point, the instrument will prompt you to apply the gas.

Apply the gas to the instrument and press and hold the right button for the interactive function "ENT" to start the Span Calibration.

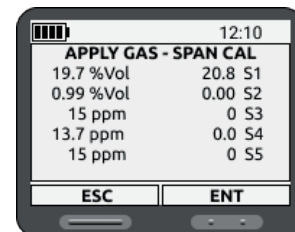

The instrument displays the screen shown on the side; the test lasts for 30 seconds.

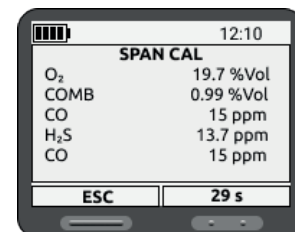

Within 30 seconds, the Span Gas Calibration is complete when the detector displays the screen shown on the side.

After completing the Calibration, stop the gas flow and remove the cap.

Then, place the instrument in fresh air.

The device displays next to the sensor whether the Calibration was successful with the following indications:

“✓” “CALIBRATION PASSED”

“✗” “ERROR - CALIBRATION NOT PASSED”

In case of an error, the symbol “⚠” will appear on the status bar at the top. In this case, press the right button for the interactive function “ESC”. Verify that the gas is reaching the instrument correctly and that the gas concentrations applied match those configured in the "GAS CAL SETUP" menu. Then, repeat the Span Calibration. If the Span Calibration is not successful, the problematic sensor must be replaced; contact the Seitron service center.

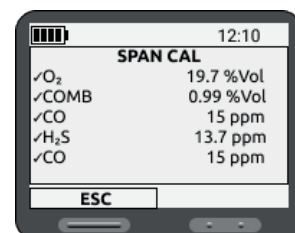

Single Gas Calibration

Zero Calibration

Once "Zero Calibration" is selected, press and hold the right button for the interactive function "ENT/▼".



Select the gas sensor to be calibrated in Zero Calibration; then press and hold the right button for the interactive function "ENT/▼".
(Example referring to the COMB sensor).

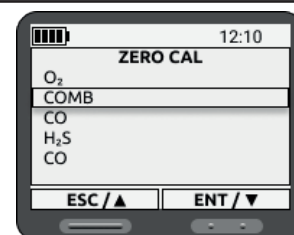

At this point, the device will prompt you to apply the gas.

Provide clean air to the device, and press and hold the right button for the interactive function "ENT" to start the Zero Calibration.

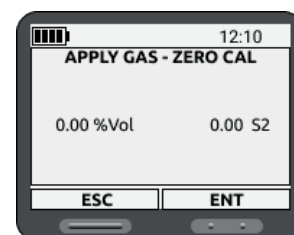

The device will display the adjacent screen; the test duration is 30 seconds.

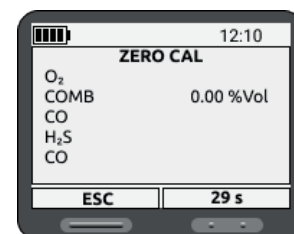

Within 30 seconds, the Zero Air Calibration will be completed when the detector displays the corresponding screen.

The device will indicate the status of the Zero Calibration next to the sensor with the following indications:

“✓” “Zero Calibration PASSED” - Proceed with the Span Gas Calibration.

“✗” “ERROR - Zero Calibration FAILED.”

In case of error, a symbol “⚠” will appear on the notification bar at the top. In this case, press the right button for the interactive function "ESC".

Check that clean air is correctly reaching the instrument's sensors, then repeat the Zero Calibration.

If the Zero Calibration is not successfully passed, the sensor causing the issue must be replaced; contact the Seitron assistance center.

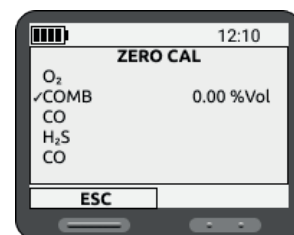

Span Calibration

Once "SPAN Calibration" is selected, press and hold the right button for the interactive function "ENT/▼".

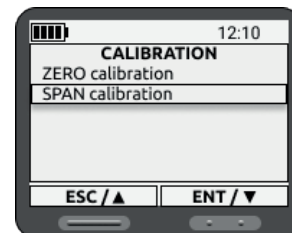

Select the gas sensor for which you want to perform the Span gas calibration; then press and hold the right button for the interactive function "ENT/▼".

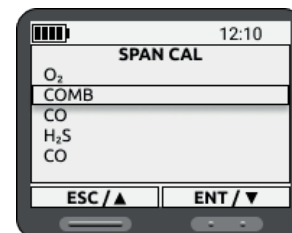

At this point, the device will prompt you to apply the gas.

Start providing gas to the instrument, then hold and press the right button related to the interactive function "ENT/▼" in order to start the Span Calibration.

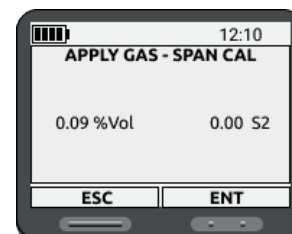

The instrument displays the screen on the side; the test has a duration of 30 seconds.

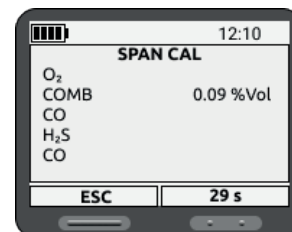

Within 30 seconds, the Span Gas Calibration will be completed when the detector displays the corresponding screen.

Once the calibration is complete, stop the gas flow and remove the cap.

Then place the instrument in fresh air.

The device will display next to the sensor whether the calibration was successful with the following indications:

“✓” “CALIBRATION PASSED”

“✗” “ERROR - CALIBRATION FAILED”

In case of error, a symbol “⚠” will appear on the notification bar at the top. In this case, press the right button for the interactive function "ESC".

Ensure the gas is correctly reaching the device and that the applied gas concentrations match those configured in the "GAS CAL SETUP" menu.

Then repeat the Span Calibration. If the Span Calibration is not successfully passed, the problematic sensor must be replaced; contact the Seitron assistance center.

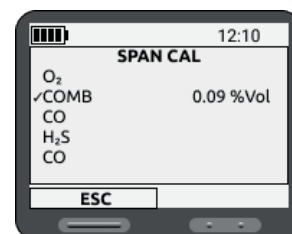

11.0 MENU

You can access the device menu only when the instrument displays the measurement screen.

To enter the menus, press and hold the button corresponding to the interactive function "ENT/▼" for at least 5 seconds.



Within the instrument's menu, the following interactive functions are available:

- "ESC/▲":** Briefly press the corresponding button to use the "▲", function (select a row or modify the value during editing).
Press and hold (>0.5 s) the button to use the "ESC" function, which cancels an unconfirmed modification or returns to the previous screen.
- "ENT/▼":** In order to use the function "▼", briefly press the corresponding button.
The function "▼" selects a row.
In order to use the function "ENT" (confirm) press and hold (>0,5 s) the relevant button.
The "ENT" function confirms the change made.
- "ENT/◀":** In order to use the function "◀", briefly press the relevant button.
The function "◀", present only when editing, selects a digit.
In order to use the function "ENT" (confirm) press and hold (>0,5 s) the related button.
The "ENT" function confirms the change made.
- "ENT":** To use the "ENT" function, briefly press the relevant button.
The "ENT" function confirms the operation.
- "ESC":** To use the "ESC" button, briefly press the relevant button. The "ESC" function cancels any unconfirmed change or, when pressed at any time, returns to the previous screen.
- "YES":** To use the "YES" button, briefly press the relevant button. The "YES" function confirms and proceeds with the requested operation.
- "NO":** To use the "NO" button, briefly press the relevant button. The "NO" function cancels the requested operation.
- "REPEAT":** To use the "REPEAT" button, briefly press its button. The "REPEAT" function repeats the test performed.

11.1 Bump Test

See chapter "9.0 BUMP TEST"

11.2 Bump Test Cylinder Conc.

See chapter "9.0 BUMP TEST"

11.3 Setup cal gas

See chapter "10.0 CALIBRATION OF THE SENSORS"

11.4 Calibration

See chapter "10.0 CALIBRATION OF THE SENSORS"

11.5 Units setup

Sets the units of measurement of gases detected by the instrument.

Briefly press one of the two buttons to select the sensor for which you want to modify the threshold.

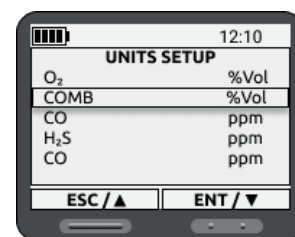

Press and hold the right button corresponding to the interactive function "ENT/▼" to enter the modification mode for the unit of measurement of the selected sensor (example refers to the COMB sensor).

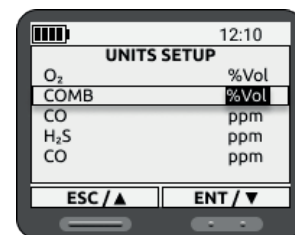

Briefly press one of the two buttons to select the desired unit of measurement.

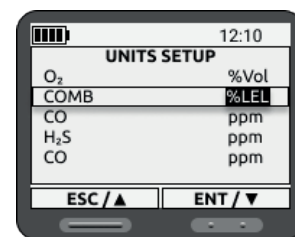

Press and hold the right button corresponding to the interactive function "ENT/▼" to confirm the modification.

Alternatively, press and hold the left button corresponding to the interactive function "ESC/▲" to cancel the modification and return to the previous action.

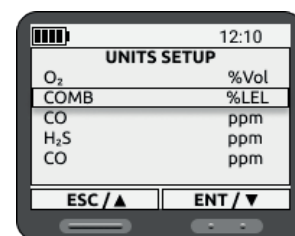

Follow the same procedure described above to configure the other measurement units.

11.6 Alarms

Through this menu, it is possible to configure the alarm thresholds for each sensor.

When the set thresholds are exceeded, the device activates all the audible, visual, and vibrating alarms available on the instrument.

To disable the alarms, it is necessary to set the alarm thresholds to zero.

Through the PC software "Be Safe MG Manager" (see Appendix B), it is possible to modify the password for accessing the Alarms menu.

Select the "Alarms" menu and long press the button related to the interactive function "SETUP/▼".

The "Alarms" menu is Password protected.

The instrument leaves the factory with Password "0000" set.

Press and hold the button related to the interactive function "SETUP/▼" to access the menu.

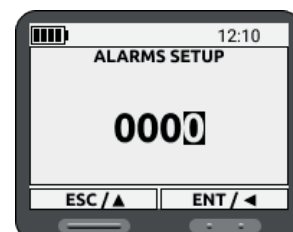

Press briefly and repeatedly one of the two buttons to select the alarm to configure.

Press and hold the right button related to the interactive function "ENT/▼" to confirm your selection.

Conversely, press and hold the left button related to the interactive function "ESC/▲" to return to the previous action.

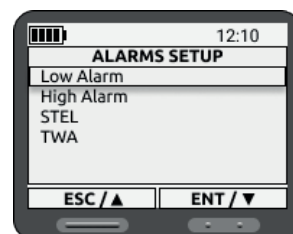

The following table shows the factory configuration of alarms and their configuration ranges.

GAS	DEFAULT SETTING			
	TWA	STEL	Low	High
H2S	10ppm	15ppm	10ppm	15ppm
CO	35ppm	50ppm	35ppm	200ppm
O2	N/A	N/A	19,5% vol.	23,5% vol.
LEL	N/A	N/A	10% LEL	20% LEL
NO2	3ppm	5ppm	3ppm	5ppm
SO2	2ppm	5ppm	2ppm	4ppm
NO	25ppm	25ppm	25ppm	50ppm
H2	N/A	N/A	50ppm	100ppm
NH3	25ppm	35ppm	25ppm	50ppm
CL2	0.5ppm	1ppm	0.5ppm	1ppm

11.6.1 Low Alarm Setup

Low Alarm is defined as the lower limit of the concentration measured by the sensors beyond which the instrument triggers low alarm alerts.

Briefly press either button to select the sensor which threshold you want to vary.

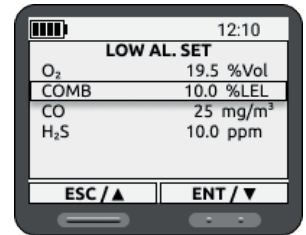

Press and hold the right button related to the interactive function "ENT/▼" to enter modification mode for the selected sensor (e.g., COMB sensor).

You can modify each digit one at a time.

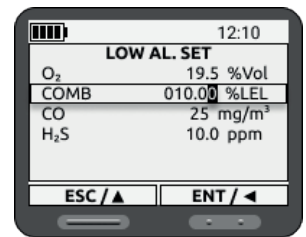

Press briefly the button related to the interactive function "ENT/◀" to select the digit to change.

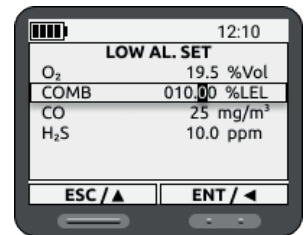

Press briefly the button related to the interactive function "ESC/▲" to change the value.

Press and hold the button related to the interactive function "ENT/◀" to confirm the modification and exit modification mode for the selected sensor. Conversely, press and hold the left button related to the interactive function "ESC/▲" to cancel the modification and return to the previous action.

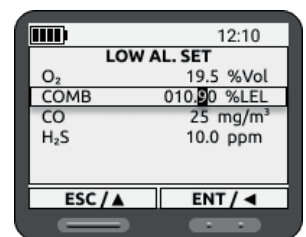

Proceed as described above to configure the "Low Alarm" for the other sensors.

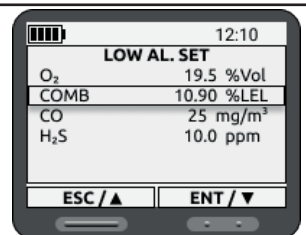

11.6.2 High Alarm Setup

The High Alarm is defined as the high alarm, which is the upper limit of the concentration measured by the sensors beyond which the device activates high alarm signals.

This threshold is also used as the peak (PEAK) alarm threshold.

Briefly press either button to select the sensor whose threshold you want to vary.

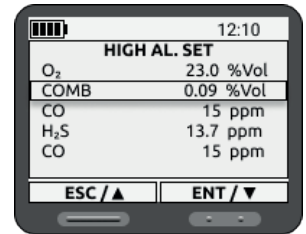

Press and hold the right button for the "ENT/▼" interactive function to enter the modification mode for the selected sensor (example refers to the COMB sensor).

It is possible to change the value of each individual digit at a time.

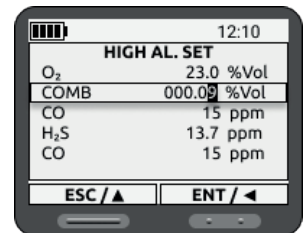

Press briefly the button for the "ENT/◀" function to select the digit to change.

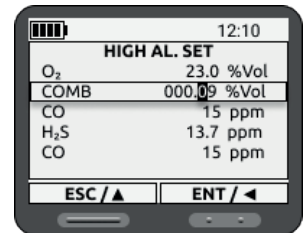

Briefly press the button related to the interactive function "ESC/▲" to update the value.

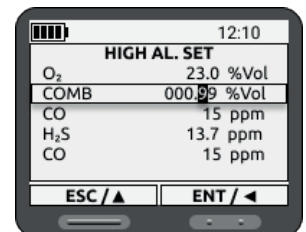

Long press the button related to the interactive function "ENT/◀" to confirm the change made and exit the edit mode of the selected sensor.

Instead, long press the left button related to the interactive function "ESC/▲" to cancel the change made and return to the previous action.

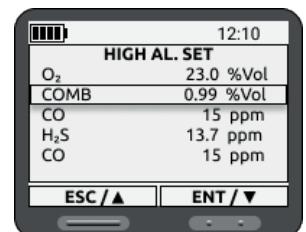

Proceed as described so far to configure the "High Alarm" for other sensors.

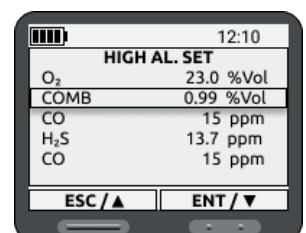

11.6.3 STEL Alarm Setup

STEL indicates the average toxic gas concentration in the environment over a 15-minute period. STEL alarm thresholds are defined in this parameter. When the STEL threshold is exceeded, the instrument activates the alarm signals.

Briefly press either button to select the sensor whose threshold you want to vary.

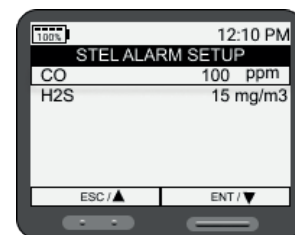

Press and hold the right button for the "ENT/▼" interactive function to enter the modification mode for the selected sensor (e.g., COMB sensor).

You can modify the value of each digit individually.

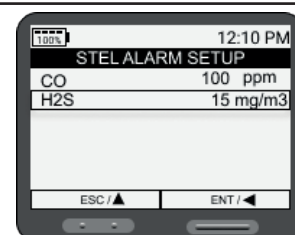

Press briefly the button for the "ENT/◀" to select the digit to be varied.

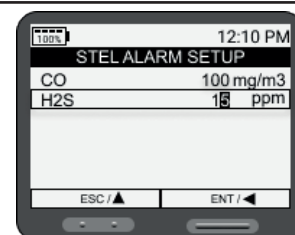

Press and hold the right button related to the interactive function "ENT/◀" to change the selected digit.

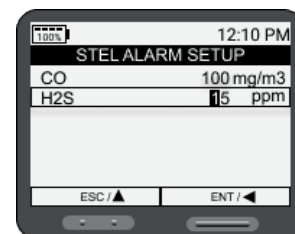

Briefly press the button related to the interactive function "ESC/▲" to vary the value.

Press and hold the button related to the interactive function "ENT/◀" to confirm the change made and exit the edit mode of the selected sensor. On the contrary, long press the left button related to the interactive function "ESC/▲" to cancel the change made and return to the previous action.

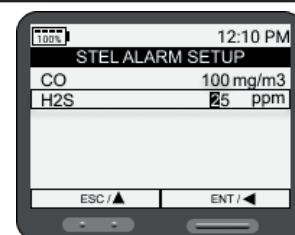

Proceed as described so far to configure the "Stel Alarm" for other sensors.

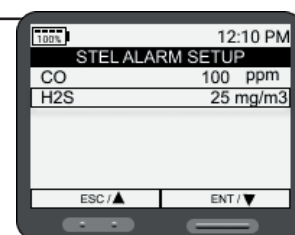

11.6.4 TWA Alarm Setup

TWA indicates the average toxic gas concentration in the environment since the first use of the device or since the value was reset to zero. TWA alarm thresholds are defined in this parameter. When the TWA threshold is exceeded, the instrument activates alarm alerts.

Briefly press either button to select the sensor whose threshold you want to change.

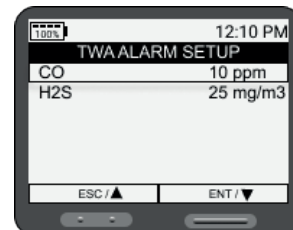

Press and hold the right button for the "ENT/▼" interactive function to enter modification mode for the selected sensor (e.g., H2S sensor).

You can modify the value of each digit individually.

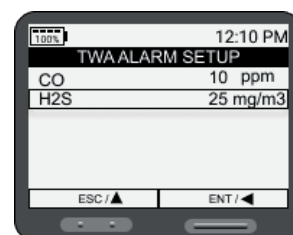

Briefly press the button related to the interactive function "ENT/◀" to select the digit to be varied.

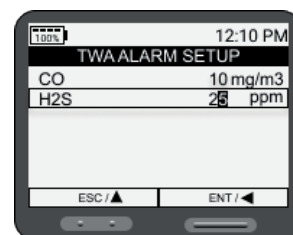

Briefly press the button related to the interactive function "ESC/▲" to vary the value.

Long press the button related to the interactive function "ENT/◀" to confirm the change made and exit the edit mode of the selected sensor. Instead, long press the left button related to the interactive function "ESC/▲" to cancel the change made and return to the previous action.

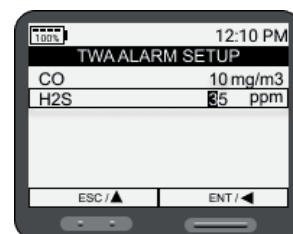

Proceed as described so far to configure the "TWA Alarm" for other sensors.

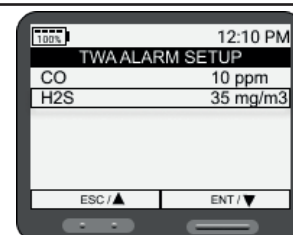

11.7 Combustible

Allows you to choose the type of fuel to be associated with the sensor displayed as "COMB"; the fuel you choose will be used in the normal operation of the device.

Using the PC software "Be Safe MG Manager" (see Appendix B), you can change the password for accessing the Fuel menu.

Select the "Combustible" menu and long press the button related to the interactive function "SETUP/▼".

The "Combustible" menu is Password protected.

The instrument leaves the factory with Password "0000" set.

Long press the button related to the interactive function "SETUP/▼" to access the menu.

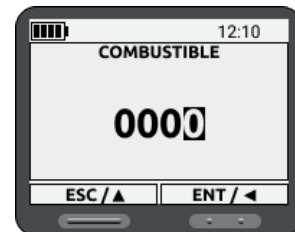

Press either button briefly and repeatedly to select the combustible.

Long press the right button related to the interactive function "ENT/▼" to confirm your choice. Instead, long press the left button related to the interactive function "ESC/▲" to cancel the change made and return to the previous screen.

After confirming your choice, long press the left button related to the interactive function "ESC/▲" to return to the previous page.

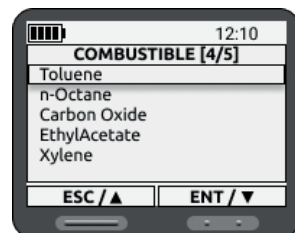
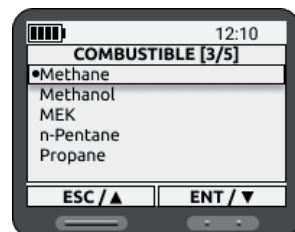
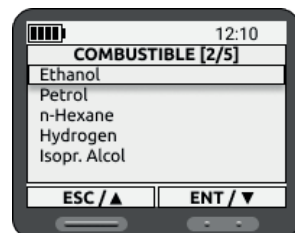
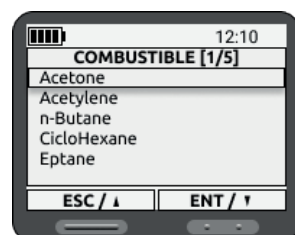

11.8 Data logging

Through this menu, it is possible to enable/disable the storage of events detected by the instrument.

Data recorded with Data logging enabled are:

Measurement

Type of gas

Value in ppm (SW converts to %Vol, LEL)

Unit of measurement

Date/Time

Temp.

Battery value (%)

Select the "Data logging" menu and long press the right button related to the interactive function "ENT/▼".

Long press the right button related to the interactive function "ENT" to enter the edit mode.

To exit without making any changes, long press the left button related to the interactive function "ESC".

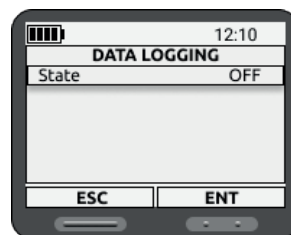

Briefly press the left button related to the interactive function "ENT/▲", to select the status:

ON: Enables event storage.

OFF: Disables event storage.

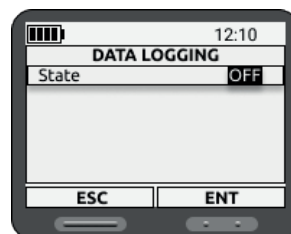

Long press the right button related to the interactive function "ENT" to confirm the change made.

Conversely, long press the left button related to the interactive function "ESC" to cancel the change made and return to the previous action.

The confirmed "ON" status, is identified by the lighting of the "☐" on the top bar of the display.

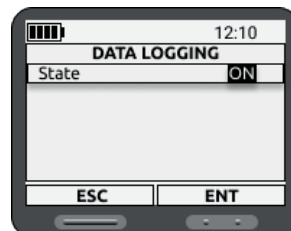

11.9 Language

Set the language of the instrument.

Select the "Language" menu and long press the right button related to the interactive function "ENT/▼".



Briefly press either button to select the desired language.

Long press the right button related to the interactive function "ENT/▼" to set the selected language.



To exit, long press the left button related to the interactive function "ESC/▲".



11.10 Clock

Allows the setting of the current time and date. It is also possible to change the format of the date and time.

Select the "Clock" menu (Clock) and long press the right button related to the interactive function "ENT/▼".



Briefly press either button to select the data to be changed.

The following is the example of changing the timetable.



Briefly press the right button related to the interactive function "ENT/▼" to select the parameter to be changed.

It is possible to change the value of each individual digit at a time.

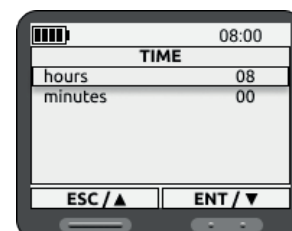

Long press the button related to the interactive function "ENT/▼" to select the digit to be varied.

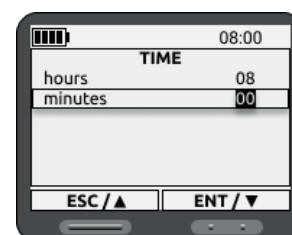

Briefly press the interactive buttons to set the desired digit.

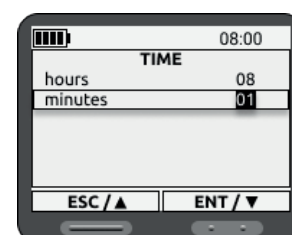

Long press the button related to the interactive function "ENT/▼" to confirm the set value.

Proceed as described above to vary the other digits.

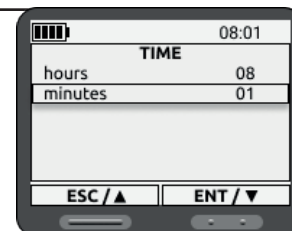

Long press the right button related to the interactive function "ESC/▲" to confirm the changes made and exit the screen and return to the previous screen.

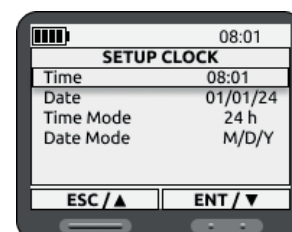

Proceed as described so far to configure the other data.

WARNING!

Time: displayed in the chosen format.

Date: displayed in the chosen format

Date format: EU (Europe) or US (America)

Time format: 24h or 12h

11.11 Device Info

Displays information about the instrument to be reported to the Service Center to be contacted in case of failure or routine maintenance. Information necessary for quick identification of the product is shown, such as instrument model, serial number, and installed firmware version.

Select the "Device Info" menu and long press the right button related to the interactive function "ENT/▼".

Mod.	Instrument model
S.N.	Instrument Serial Number
SW Ver.	Software version installed on instrument
BOOT Ver.	Boot version

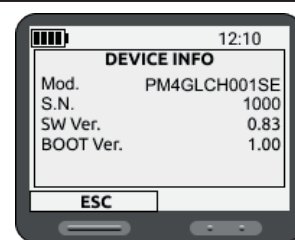

11.12 Service

Display a QR code.

Scan the QR code with a QR code reader to get all the information about authorized service centers.

Select the "Service" menu and long press the right button related to the interactive function "ENT/▼".



11.13 Reset Password

For Password Reset contact Seitron service center.

11.14 Operator

This submenu displays information regarding the operator using the instrument.

Data regarding the operator can only and exclusively be entered via PC after installing the "Be Safe MG Manager" software.

Select the "Operator" menu and long press the right button related to the interactive function "ENT/▼".



11.15 Diagnostics

The user, through this menu, can check all data related to the sensors installed on the instrument.

Press the right button related to the interactive function "ENT" to go to the next screen. On the contrary, long press the left button related to the interactive function "ESC" to return to the previous page.

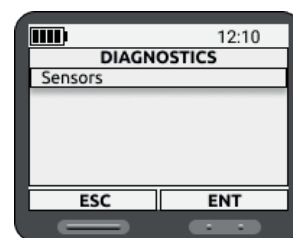

Briefly press one of the two buttons to select the sensor for which you want to check the data.

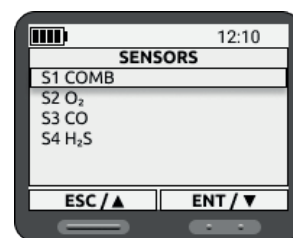

Briefly press either button to move to the next page.

Detail:

Part number: Sensor code.

S/N: Serial number.

Last calibration: Date related to the last calibration performed.

Next Calibration: Date useful for scheduling the recalibration of the sensor.

Bump Test: Date for the last bump test performed.

Sensor Life: Expected life of sensor* since first use in days.

EOL: End of sensor life - time remaining in days to schedule sensor replacement.

LifeTime: Time to actual power on in days.

AbsLifeT: Days elapsed since first use of the sensor in days.

1st ON: Date of first power on.

* EOL+AbsLifeT=Expected life.



11.16 Debug Service

The menu is password-protected for use only by Seitron-authorized service centers.

12.0 MAINTENANCE

WARNING!

Any repairs or modifications to the device beyond the procedures described in this manual or performed by personnel not authorized by Seitron may cause the unit to malfunction.

Failure to observe this warning may result in serious injury or death.

12.1 Routine maintenance

This instrument is designed and manufactured using high quality components.

Proper and systematic maintenance will anticipate the occurrence of malfunctions and increase the overall life of your instrument.

The basic operations to be performed by the operator are listed below:

- Before turning off the device, have it draw in clean air for a few minutes, or at least until the displayed parameters return to their default state:

O₂: >20.0%

Toxic gases: <20ppm

12.2 Cleaning

Routine cleaning

Regularly clean the outside of the device using only a damp cloth. Do not use detergents as many of them contain silicone, which will damage the sensors. Do not use abrasive detergents, thinners and other similar cleaners to clean the instrument.

Exposure to dirt and dust

Use a dry soft-bristled brush to remove dust and dirt accumulated on the equipment, especially at the sensor openings. If there is an accumulation of dust or dirt particles remaining in the sensor area after brushing, use a vacuum cleaner to remove the remaining particles, but maintain a distance of at least 1.3 cm (1/2 inch) from the gas detector.

Exposure to water

If the equipment is exposed to water, rotate the device with the sensor side down and gently shake the water out of the sensor area and sound outlet cavity. Residual water can be removed with a clean, dry cloth.

12.3 Scheduled maintenance

At least once a year, send the instrument to the SERVICE CENTER for a thorough review and internal cleaning.

The highly qualified SEITRON staff is always available for any type of commercial, technical, application, and maintenance information.

The service team is always ready to return the instrument to you as if it were newly manufactured, in the shortest time possible. Calibrations are performed with gases and instruments traceable to National and International Standards. The annual review, complete with a calibration certificate, ensures the instrument's perfect operation.

12.4 Replacing gas sensors

To replace gas sensors, send the instrument to Seitron's authorized service center.

12.5 Replacing gas sensor filters

For replacement of gas sensor protection filters send the instrument to Seitron authorized service center.

12.6 Instrument expandability

If the instrument is expandable, and you wish to install additional sensors, you will need to send the instrument to the Seitron authorized service center.



12.7 Replacing the internal battery

For battery replacement, send the instrument to Seitron authorized service center.

13.0 TROUBLESHOOTING AND FAULTS

If an error occurs during operation, use the indicated error codes to determine the appropriate measures. This device should be checked and maintained regularly by competent technicians.

13.1 Troubleshooting

PROBLEM	DESCRIPTION	REACTION
"ERROR" on one or more sensors.	Autozero was not performed in clean air.	Move the instrument or sampling point to clean air and repeat Autozero. If the problem persists, contact the authorized service center.
Instead of the gas concentration the following symbol appears: 	The measured gas is above the measuring range of the sensor.	The instrument is in an alarm state because it has exceeded the set HIGH alarm thresholds. Leave the area immediately.
Instead of the gas concentration the following symbol appears: 	The measured gas is less than the measuring range of the sensor. Applicable to Oxygen sensor only.	The instrument is in an alarm state because it has exceeded the set LOW alarm thresholds. Leave the area immediately.

14.0 SPARE PARTS AND SERVICE

14.1 Spare parts

CODE	DESCRIPTION
AMGC01	Gas Tester
AMDS01	Charging, Communication and Bump Test Station
AMKF01	Filter Kit for AMAF01 - 8 pcs

14.2 Accessories

CODE	DESCRIPTION
AMKA01	Power supply kit: USB cable + power supply + plugs (EUROPEAN - UK - USA - Australia - China)
AMAF01	External dust filter
AMSD01	Wall or DIN rail mounting adapter for AMDS01
AMKP01	Gas Tester Kit + External Dust Filter

14.3 Service centers

Seitron S.p.A. a socio unico

Via del Commercio, 9/11
 36065 Mussolente (VI)
 Tel.: +39.0424.567842
 Fax.: +39.0424.567849
 E-mail: info@seitron.it
<http://www.seitron.it>

Seitron Service Milano

Via Leonardo da Vinci, 1
 20090 Segrate (MI)
 Tel. / Fax: +39.02.836.476.71
 E-mail: service.milano@seitron.it

For NORTH AND SOUTH AMERICA

Seitron Americas Inc

140 Terry Drive Suite 101
 Newtown PA 18940 - USA
 Tel.: (215) 660-9777
 Fax.: (215) 660-9770
 E-mail: service@seitronamericas.com
<http://www.seitronamericas.com>

APPENDIX A AMDS01 (BATTERY CHARGING AND COMMUNICATION STATION)

Battery charging and communication station interface for Be Safe MG series personal gas detectors --.

Main functions:

- Charging the internal battery of Be Safe MG series personal gas detectors --.
- Can be connected to the computer via USB connection, after installing the appropriate Be Safe MG manager PC software, to perform the following main functions:
 - Instrument configuration
 - Bump test
 - Calibration
 - Data log transfer
 - Firmware upgrade

Usage:

1. Stand on a tabletop or DIN rail/wall mount using the AMSD01 station.

1.1 Mechanical description

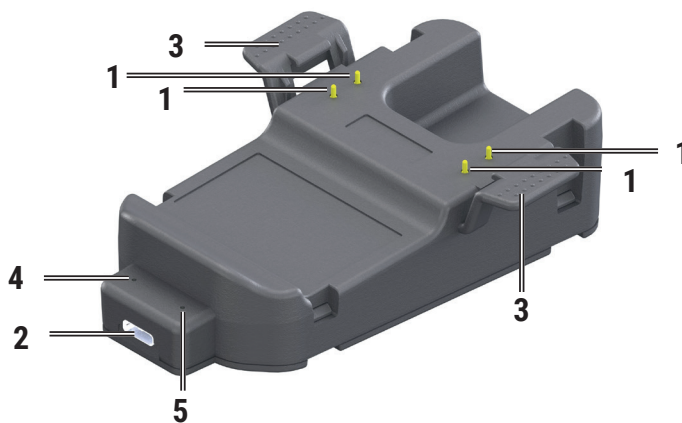

1	Communication port with the instrument.
2	USB type C connector for connection to battery charger or PC.
3	Locking tabs for securing the instrument.
4	Green LED: Steadily lit: The docking station is powered.
5	Red LED: Steadily lit: The instrument battery is charging.

1.2 Dimensions

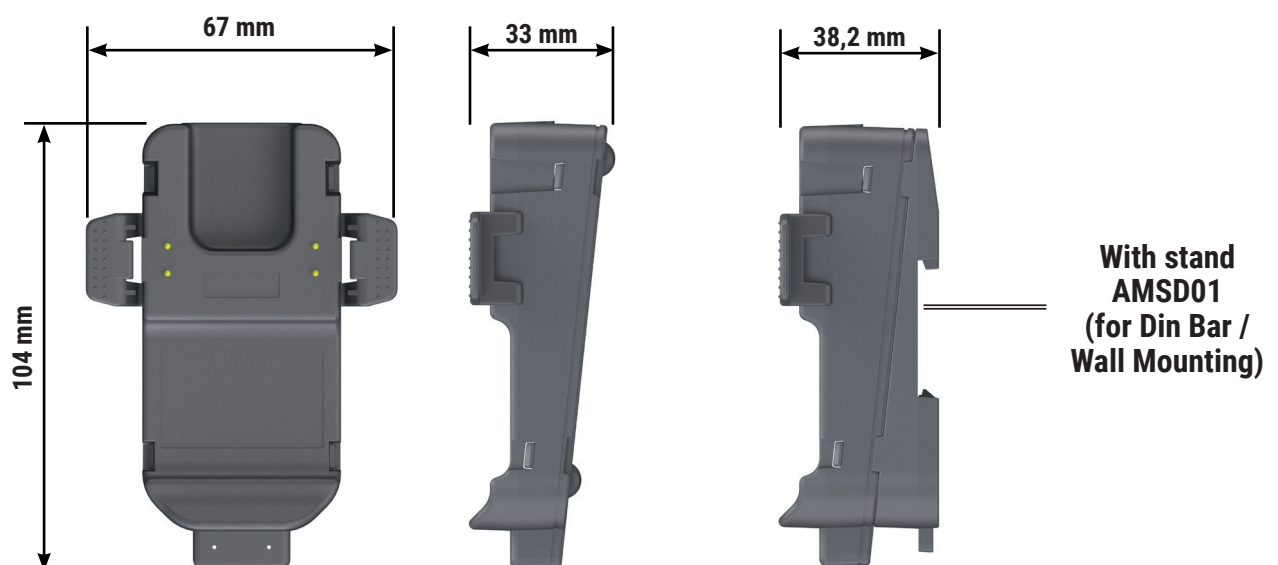

1.3 Technical Features

Power supply: 5Vac 500mA via USB type C connector

Conditions of use

Usage: Inside buildings in safe areas.

Temperatures: -5°C .. +45°C

Humidity range: 5% .. 90% RH, non-condensing

Storage

Storage temperature range: -20°C .. +55°C

Humidity limit: 5% .. 90% RH

1.4 Charging station use and communication



APPENDIX B Software PC "Be Safe MG Manager"

The **Be Safe** MG multi-gas detector through the AMDS01 charging and communication station, is able to communicate with the PC, upon installation on the PC of the "**Be Safe MG Manager**" software, which can be downloaded from the **Microsoft store**.

The main operations that can be performed through the "Be Safe MG Manager" PC software are as follows:

- Setting the cylinder gas concentrations for performing the Bump Test;
- Performing the Bump Test;
- Configuration of: Language, Date and Time, Operator Name and Unit of Measurement;
- Display of all instrument configuration parameters;
- Reading and exporting to .csv file of measurements made and events;
- Updating firmware of gas detectors.

Instructions for installing the software

1. Go to the Microsoft store and search for the "Be Safe MG Manager" App.
2. Access the page for the "Be Safe MG Manager" App.
 - 2a. From App Microsoft store, click on "Get": the App will install automatically and when the installation is finished click on "Open".
3. From the web page, click on "Download".
4. A .exe file download will start. Once the download is finished, on your browser click on the top right button to access the Windows "Download" folder.

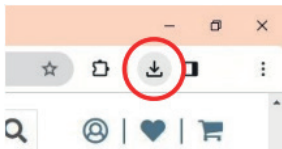

WARNING: The symbol may vary depending on the browser being used.

6. Double-click on the previously downloaded "Be Safe Personal Monitor Installer.exe" file (step 4).
7. The App installs automatically and eventually the login screen of the Be Safe MG Manager software opens. If you have a Seitron account, fill in the required data and click on **Accedi**. If you do not remember the password, click on **"Retrieve Password"**.

Otherwise, proceed as described in step 8.

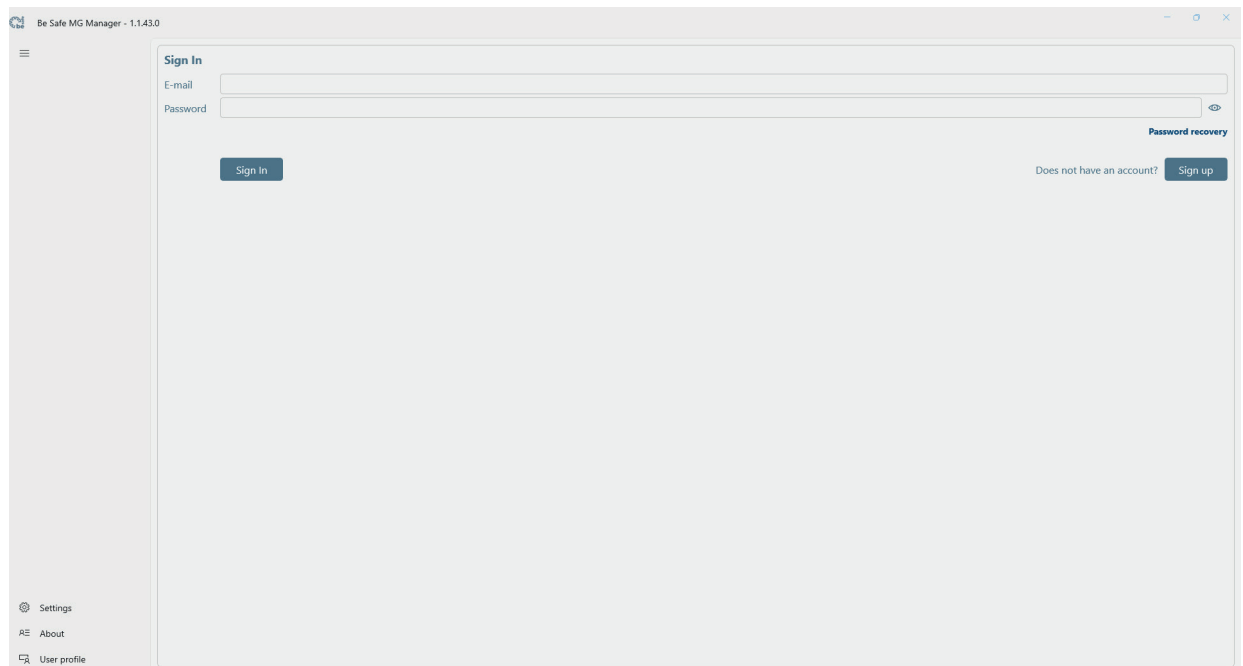

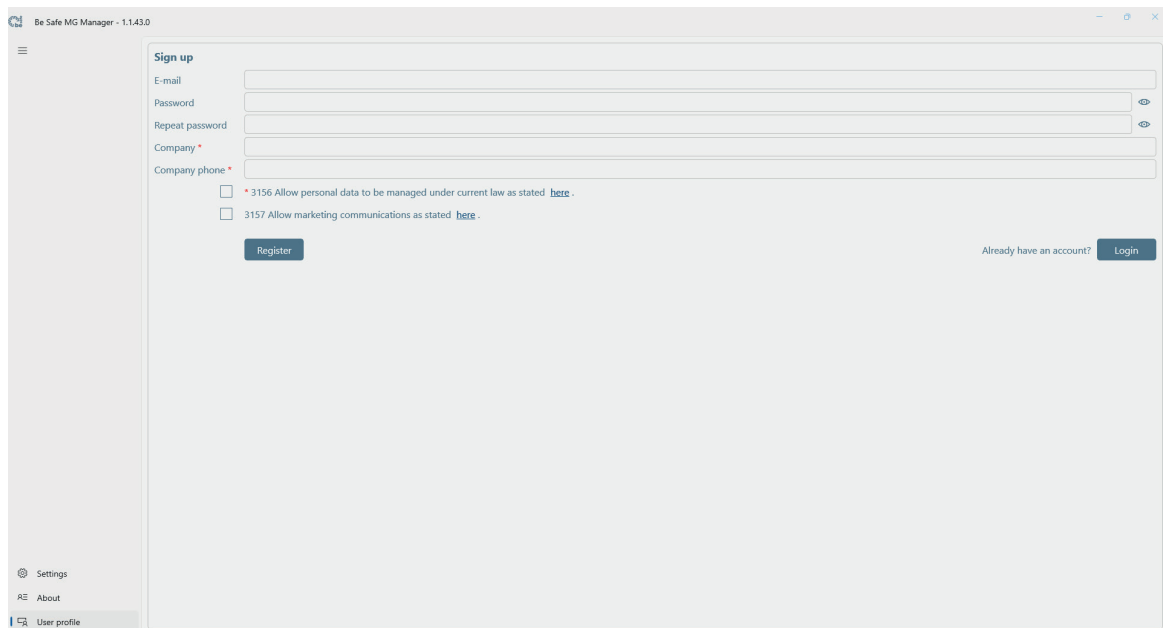

8. To access the software features, it is necessary to register with company data; click on **Sign up** and proceed to fill in the required data and click on **Register**.

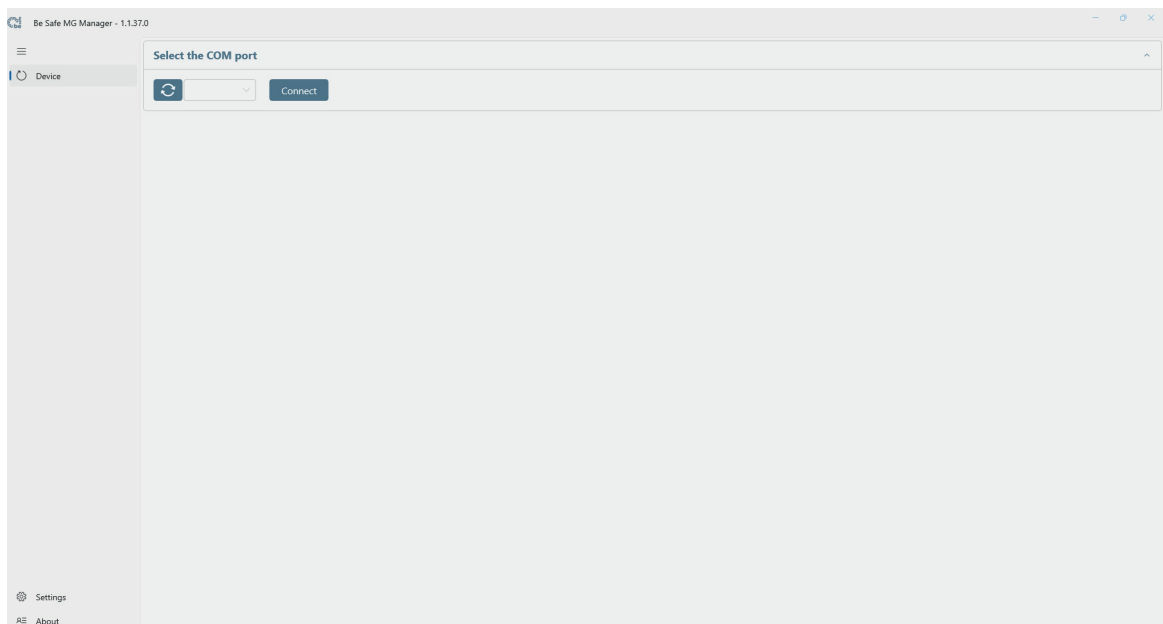

9. After logging in, the startup screen of the Be Safe MG Manager software is accessed.



Connect Be Safe MG

8. Turn on **Be Safe MG** and wait for the startup procedure; the instrument should display the "MEASURE" screen.
9. Plug in Be Safe MG multigas detector on **AMDS01** (see Appendix A).
10. Connect AMDS01 to the PC using the USB cable provided.
11. Click on the button  to scan the communication port.
12. Click on  to select the COM port to which the device connects; then press the button **Connect**.
13. The main screen of the software is accessed, while the display of the instrument displays the following screen:

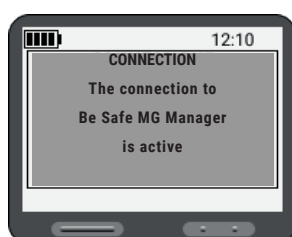

When the instrument is connected to “Be Safe MG Manager”:

- All alarms are disabled.
- The buttons on the instrument are disabled.

User's Guide

Device screen:

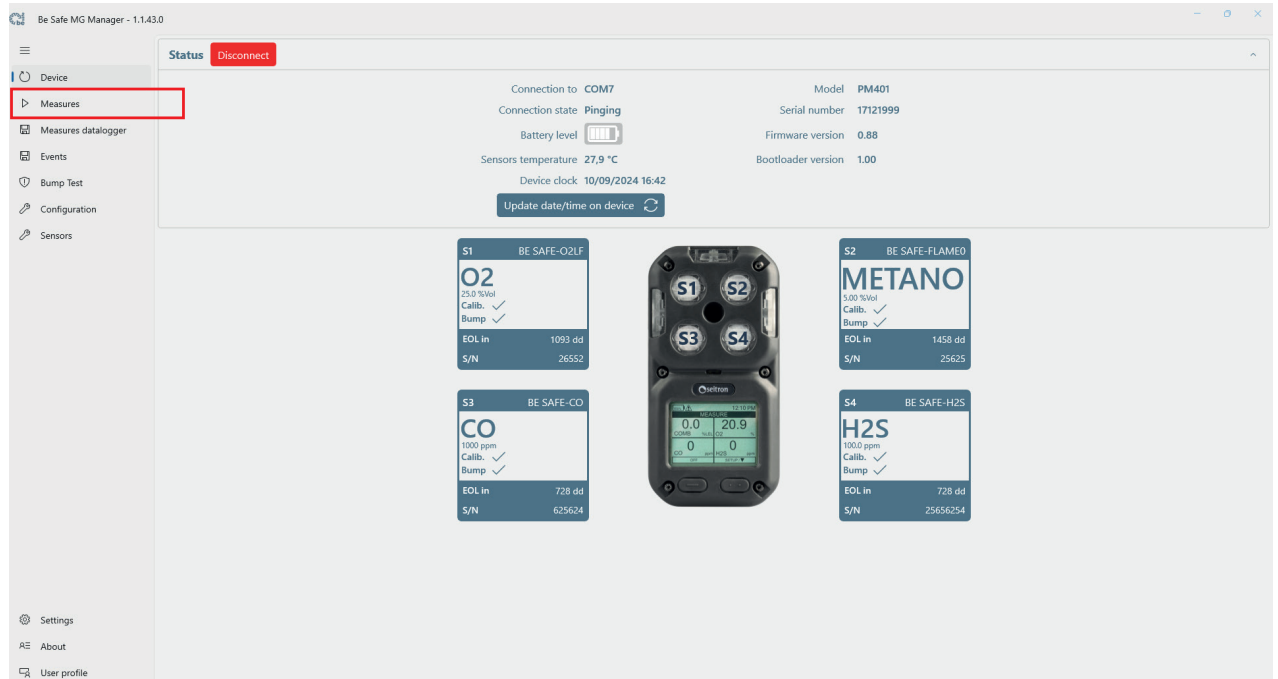

Status button

By clicking on the Status button you can display or not display the main data of the instrument. With the Status visible, you can click on the “Update date/time on device” button to synchronize the PC date and time on the instrument.

The image of the instrument and the arrangement of the sensors and their status, is always visible.

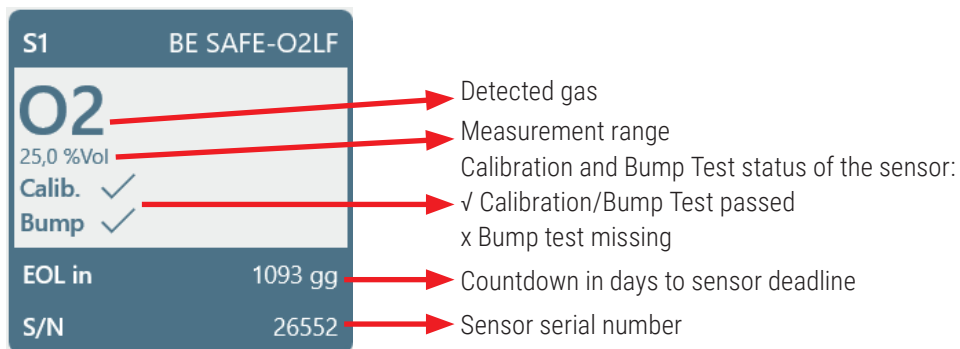

Disconnect button

Clicking the button Disconnect will disconnect the instrument.

Measure screen:

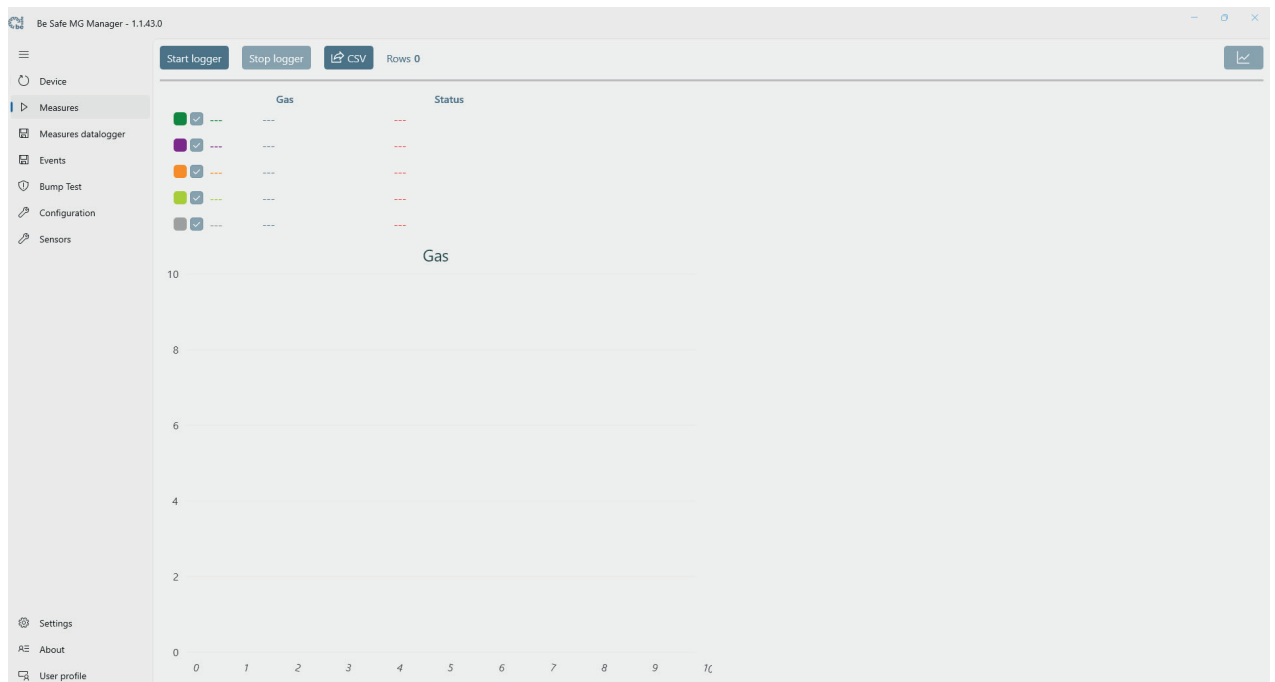

In this screen you have the option to remotely start the acquisition of real-time measurements.

"Start logger" Button

By clicking on the button , the recording of real-time measurements is started.

An example screen during the recording of measurements can be seen at the side.

At the top, each gas is identified by a color, where the concentration detected and the status of the sensor is shown.

At the bottom, the measurements taken are plotted in a graph at each sampling.

Clicking on the button  instead of the graph displays the detail of the measurements being acquired. This button is active only during the recording of real-time measurements.

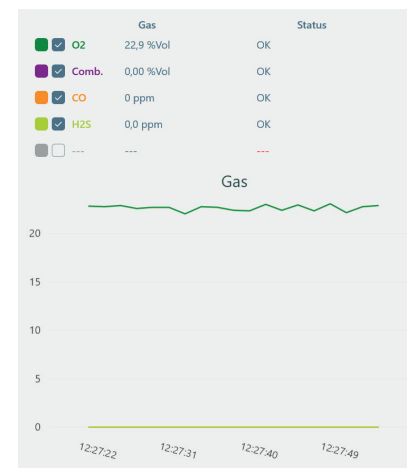

"Stop Logger" Button

Clicking the button , exits the measurement recording mode; the screen displays the last stored sampling.

"Export .csv" Button

Click the button , export the recorded samples to a .csv file.

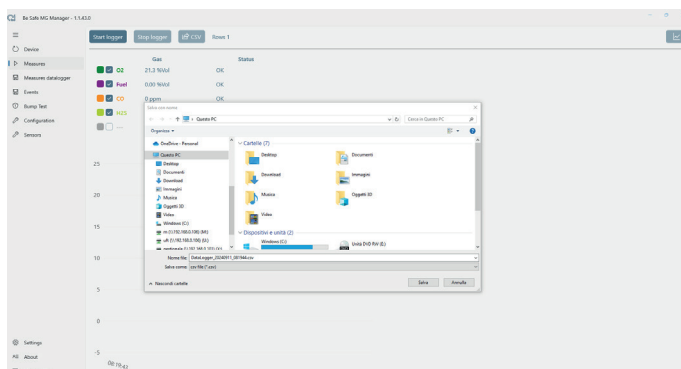

Data logger measurements screen:

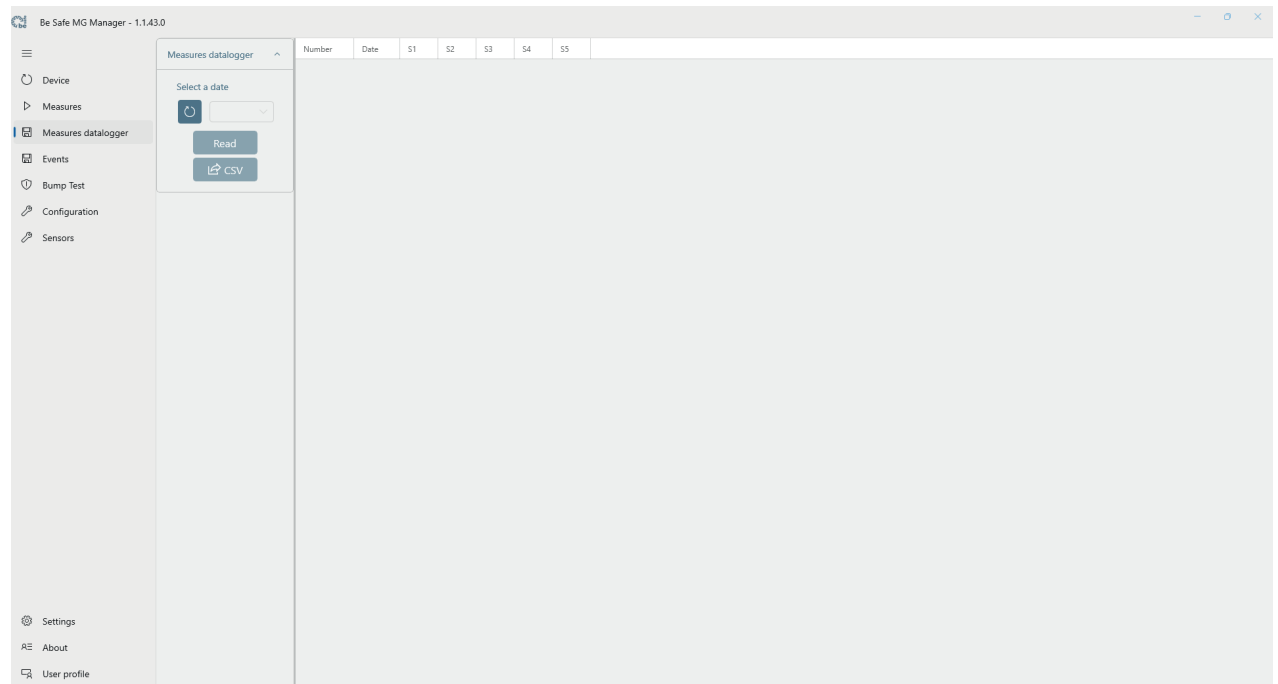

In this screen you can read and export to a .csv file the measurements in the instrument memory.

"Update" Button

By clicking on the button , the software reads the contents of the instrument memory by sorting the measurements by date; the last recorded measurement is displayed on the side pane.

By clicking on the date box, the list of measurements to be displayed and/or exported can be displayed by date.

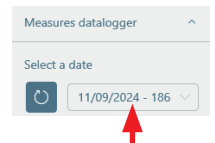

"Read" Button

Once one of the proposed dates is selected, clicking the button  displays all the samplings made on the selected date.

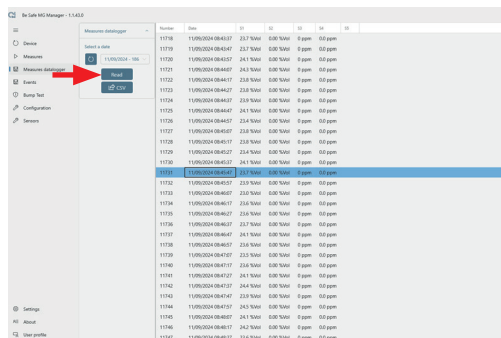

Where:

Number:

Date:

S1 / S2 / S3 / S4 / S5:

ID number.

Date and time of the sampled measurements.

Sensor location corresponding to the detected gas concentration.

"Export" Button

After selecting a date, and clicked the button , click on  to export the measurements to a .csv file.

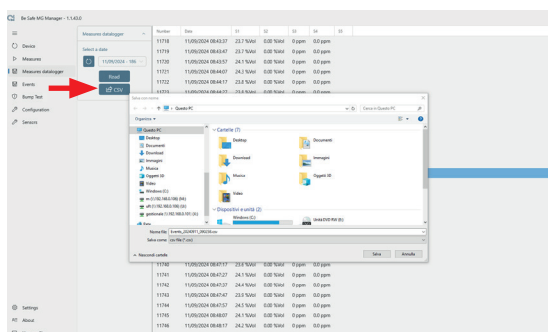

Events screen:

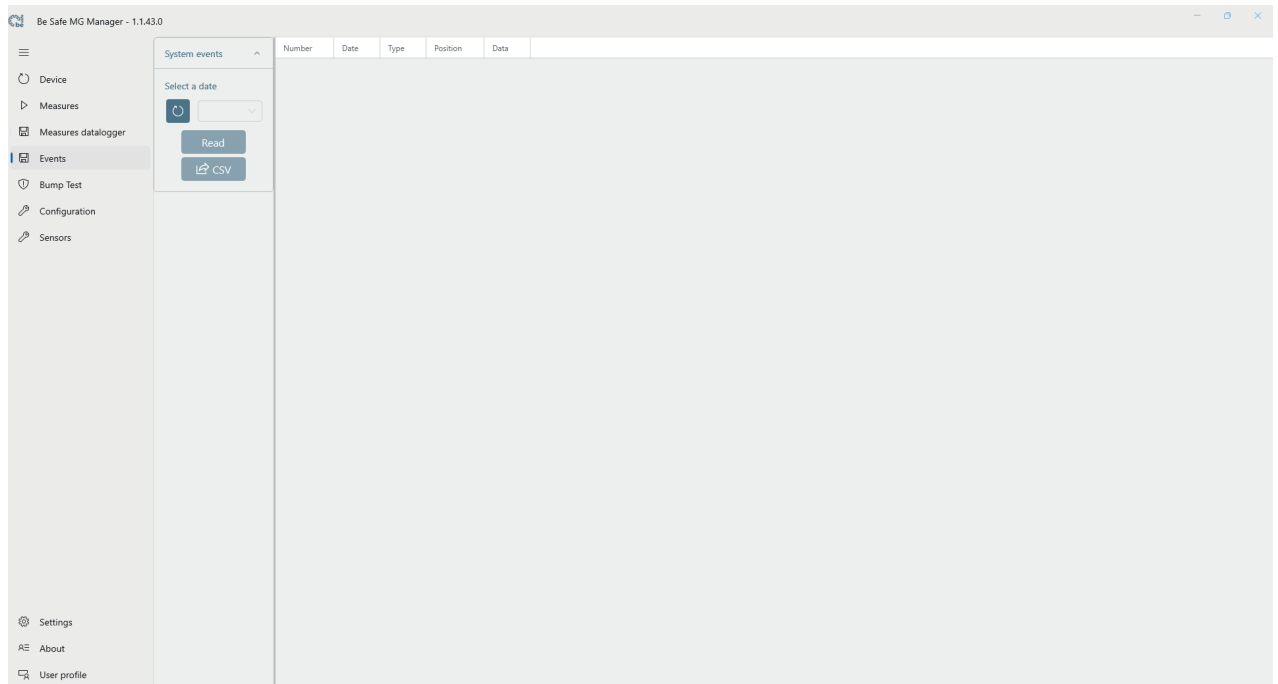

In this screen, you can read and export the list of events that occurred and were stored on the device to a .csv file.

"Update" Button

Clicking the button , retrieves the content of the device's memory, sorting the events by date; the last recorded event is displayed in the adjacent panel. By clicking on the date panel, you can view and export the list of events by date.

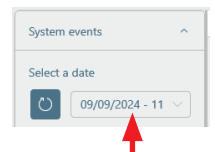

"Read" Button

After selecting one of the proposed dates, clicking the button  displays all the events that occurred on the selected date.

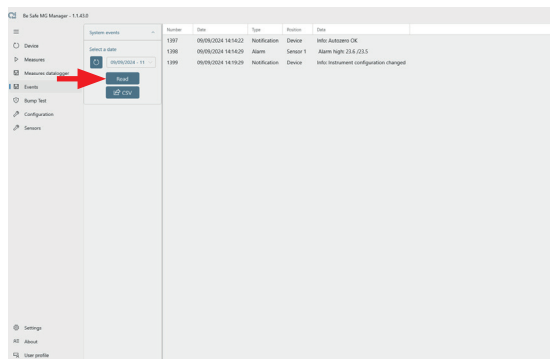

Where:

Number: ID number

Date: Date and time of the event.

Type: Type of detected event.

Position: Sensor that detected the event.

Data: Event type - gas concentration - alarm threshold.

"Export" Button

After selecting one of the proposed dates, and clicking the button , click the  button to export the displayed events to a .csv file.

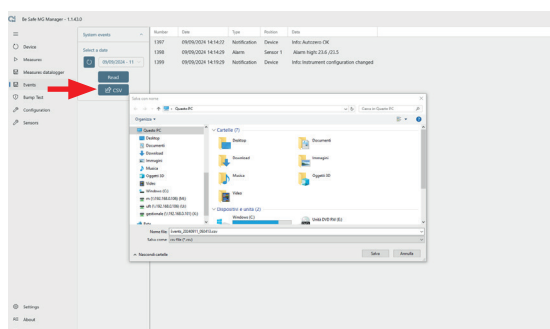

Bump Test Screen

In this screen, you can perform the Bump Test on the gas sensors of the device connected to the PC, configuring the data for the cylinder used during the test.

No other configuration is allowed.

From the PC, you can run the Bump Test for a single gas or for all 4 gases simultaneously. It is not possible to run the test for 2 or 3 gases at a time.



1	Bump Test Duration: Execution time in seconds; configurable.
2	Start Bump Test: Starts the Bump Test for the selected sensors. Follow the on-screen instructions. WARNING! The button is active only if one or four sensors are selected.
3	Stop Bump Test: Stops the Bump Test.
4	Sensor Selection Button: Left = sensor NOT selected, Right = sensor selected.
5	Sensor Data: Gas concentration of the cylinder used for the Bump Test; configurable.
6	Gas concentration of the cylinder in use for the Bump test; configurable setting.
7	Cylinder Batch Number: Batch number of the cylinder used for the Bump Test; configurable.
8	Real-Time Measurement Graphs.



WARNING!

Before performing the Bump Test, carefully read Chapter "9.0 BUMP TEST!"

Configuration Screen:

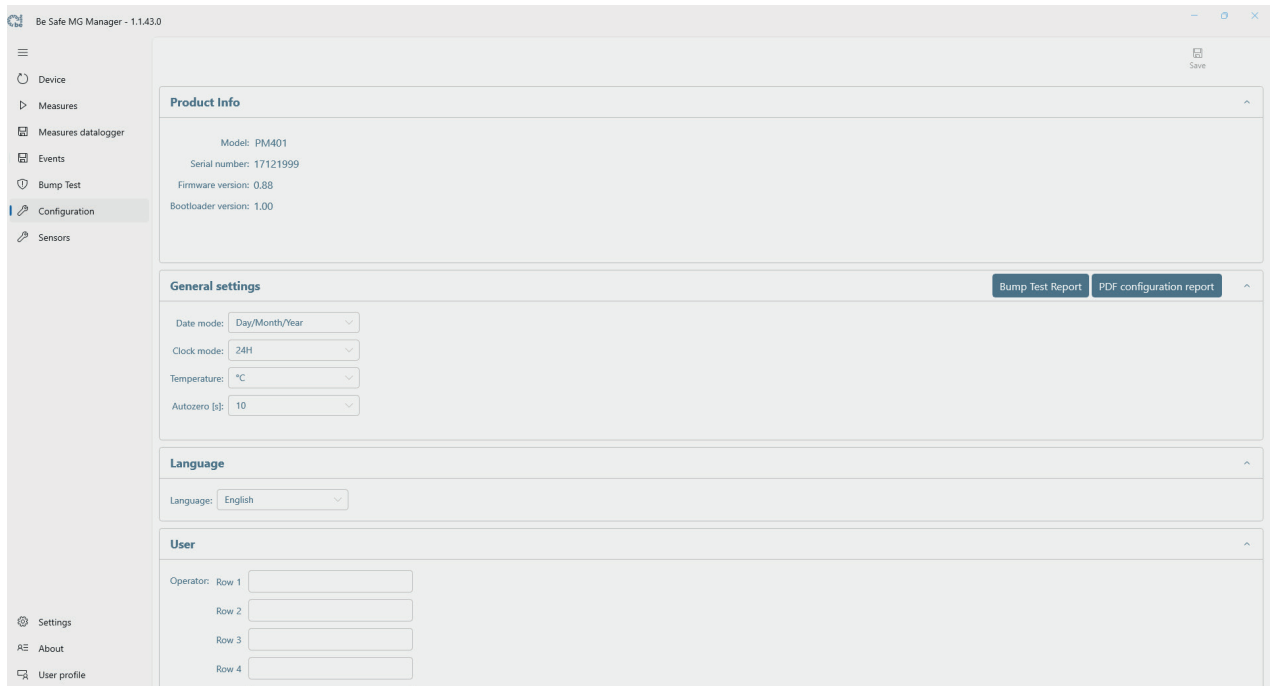

In this screen, you can configure the main device settings, view key factory data, and export configuration and Bump Test reports.

"Product Information"

The serial number of the device and the installed firmware version are displayed.

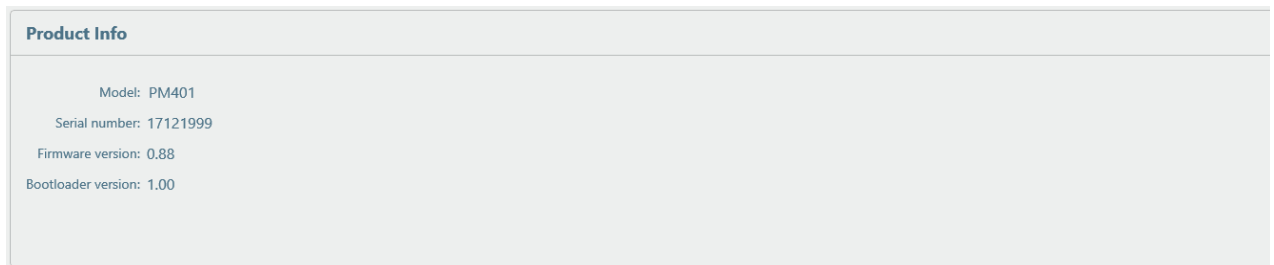

"General settings"

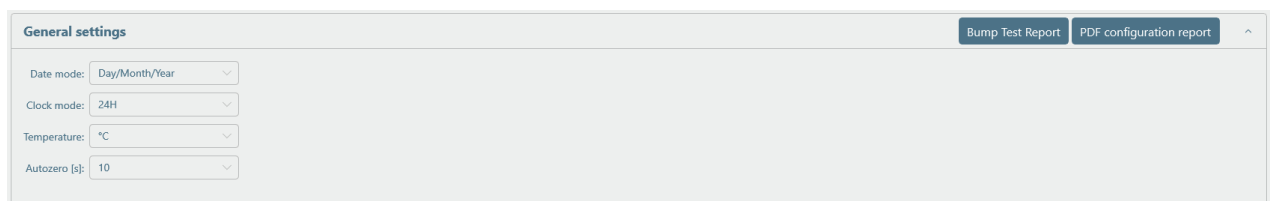

By clicking the buttons **Bump Test Report** and **PDF configuration report**, you can export the reports of the performed Bump Test and the device configuration to a .pdf file.

Additionally, you can configure the main device settings:

Date format

Time format

Temperature unit

Auto-zero duration (in seconds)

For each change made, the software prompts you to either cancel or save the changes by clicking one of the buttons that appear at the top:

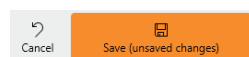

"Language"

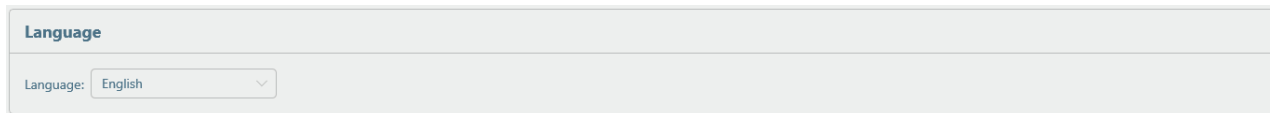

Configure the device language.

For each change made, the software prompts you to either cancel or save the changes by clicking one of the buttons that appear at the top:



"User"

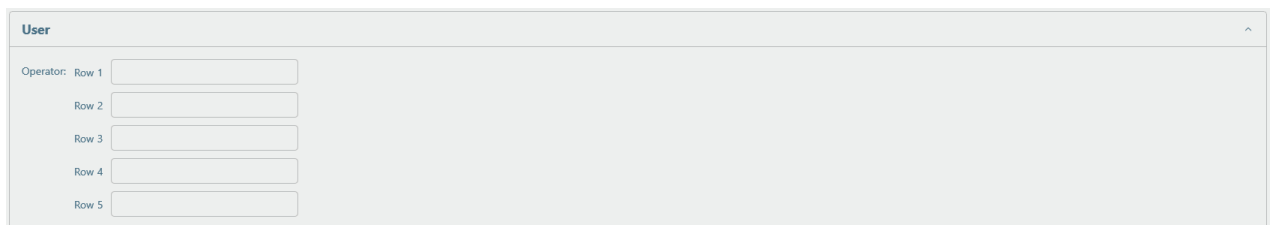

Set the name or names of the operators using the device; up to 22 characters, including spaces, are available.

For each change made, the software prompts you to either cancel or save the changes by clicking one of the buttons that appear at the top:



"Sensors" Screen

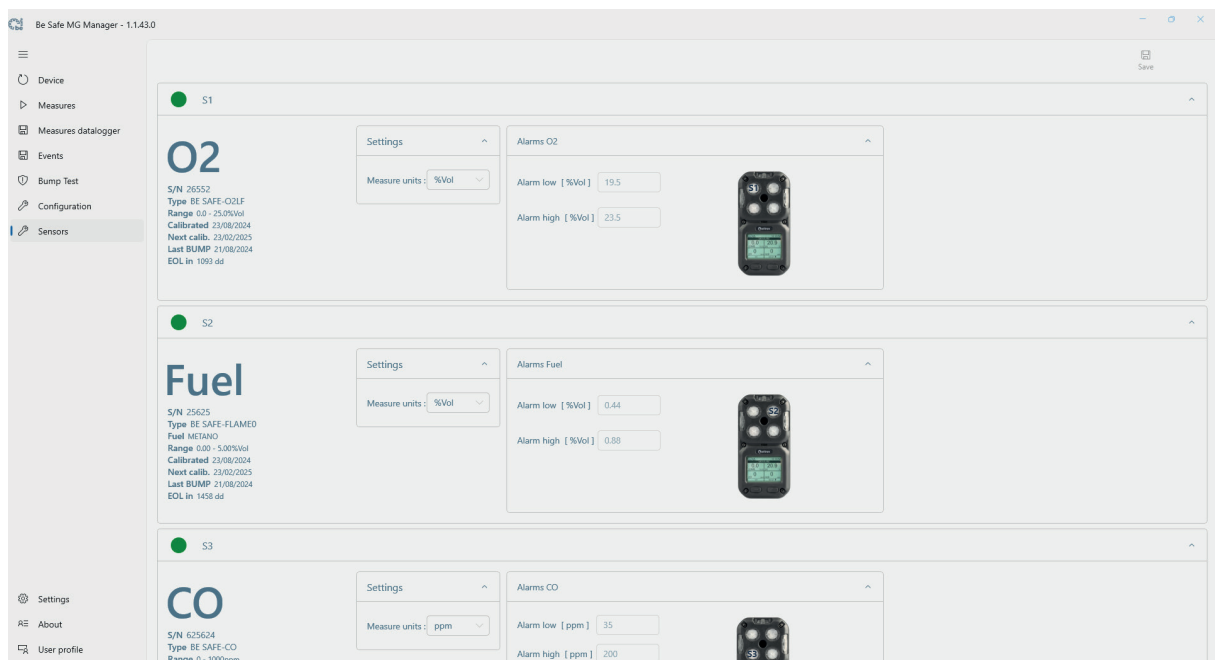

Displays the data for each sensor installed on the device, with the option to set the gas concentration unit of measurement.

For each change made, the software prompts you to either cancel or save the changes by clicking one of the buttons that appear at the top:



Settings Screen:

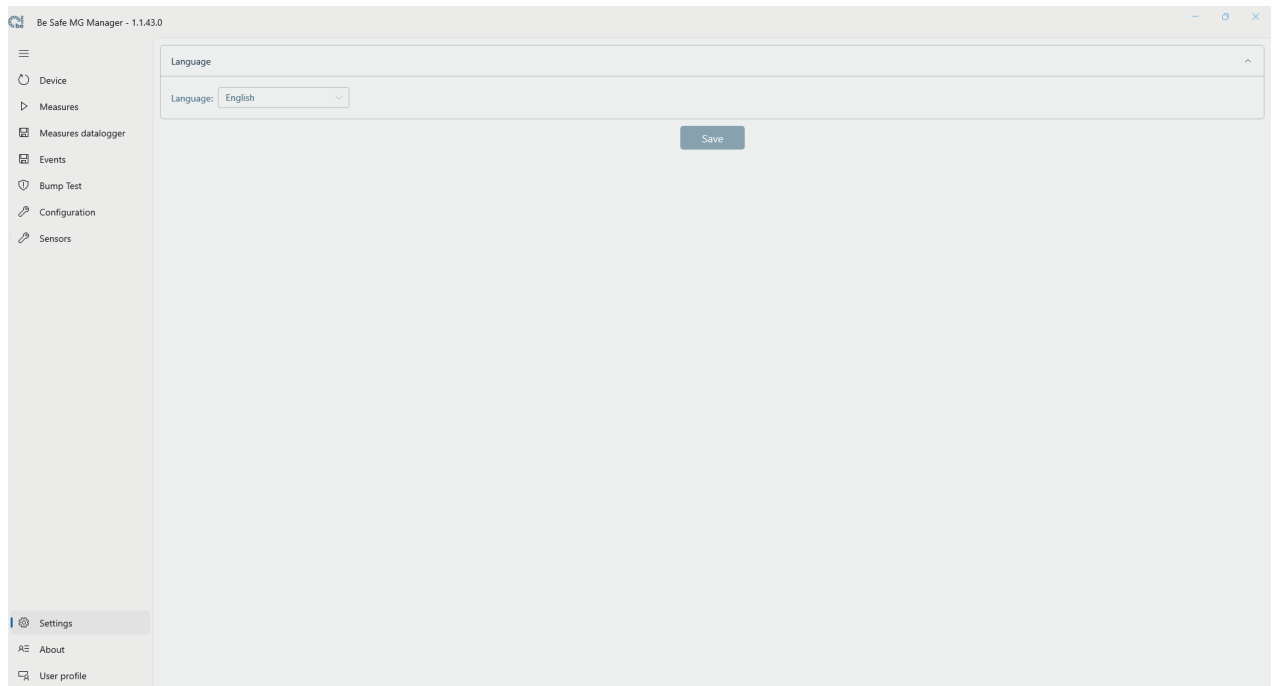

Configure the language of the **Be Safe MG Manager** software.

Click the button  to save the changes.

About screen:

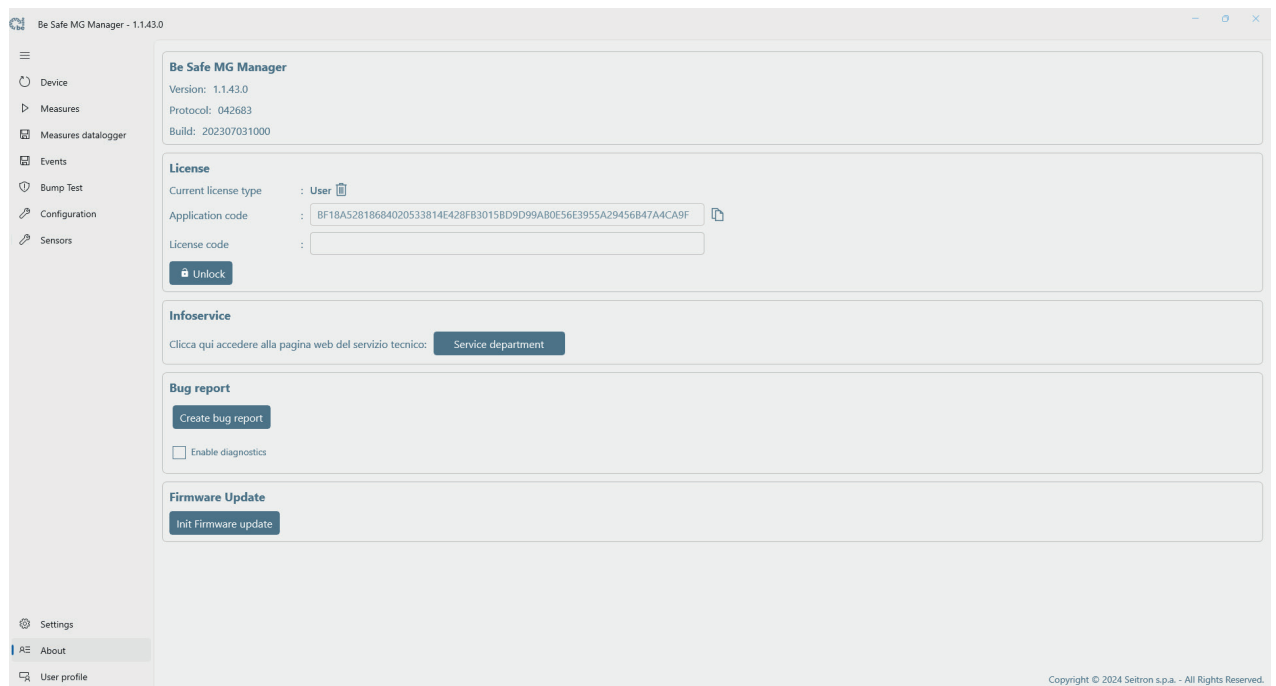

Be Safe MG Manager

View Software Data.

License

Reserved for service centers.

Infoservice

Click the button  to access the list of authorized service centers.

Bug Report

Reserved for service centers.

Firmware Update

Use this function to update the device's firmware.

Before starting the firmware update procedure, contact the service center to check for any firmware updates and obtain the latest firmware version.

Click the button  to begin the firmware update procedure and follow the on-screen instructions.

User Profile Screen:

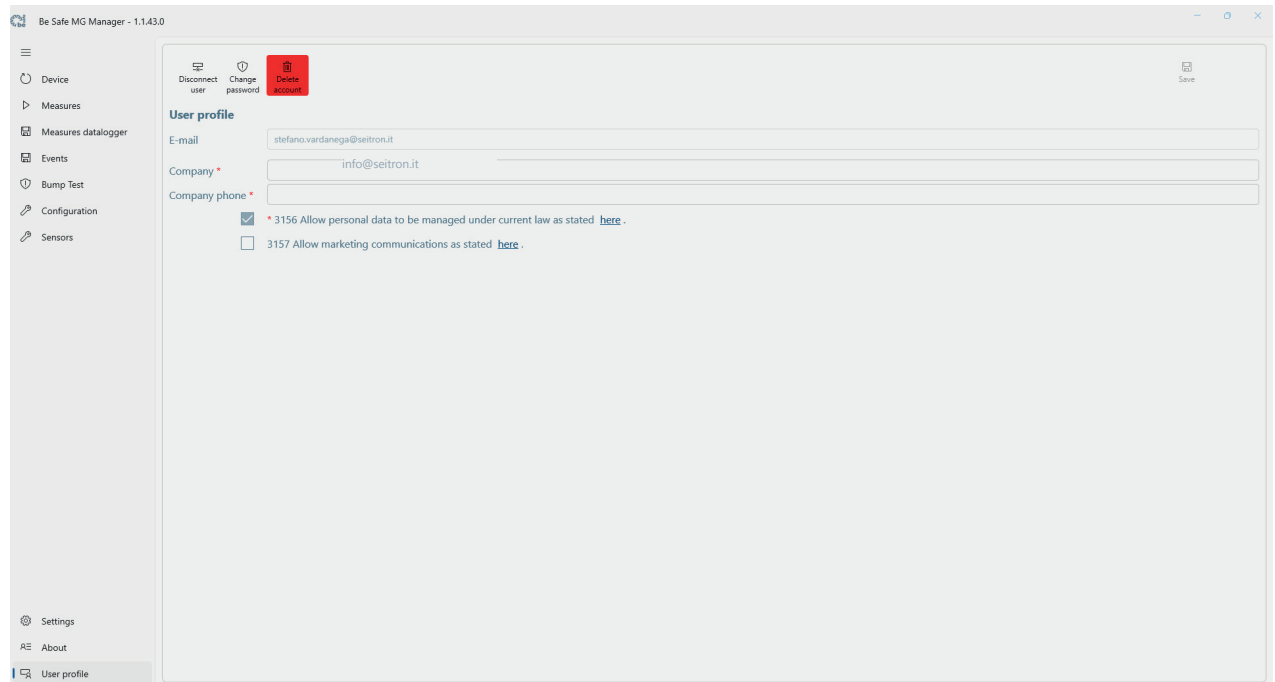

Disconnect user

Signs out of the account.

Change Password

Starts the procedure to change the password.

Delete account

Removes the account from the Seitron database.

In this screen, you can update the company name, phone number, and consents for privacy and commercial communications. For each change made, the software prompts you to either cancel or save the changes by clicking one of the buttons that appear at the top:

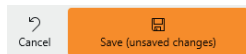

APPENDIX CAMSD01 (MOUNTING BRACKET FOR AMDS01)

Accessory for Mounting AMDS01 on DIN Rail or Wall.

Supported DIN Rails: TS35/7.5 or TS35/15

1.0 Mechanical Description

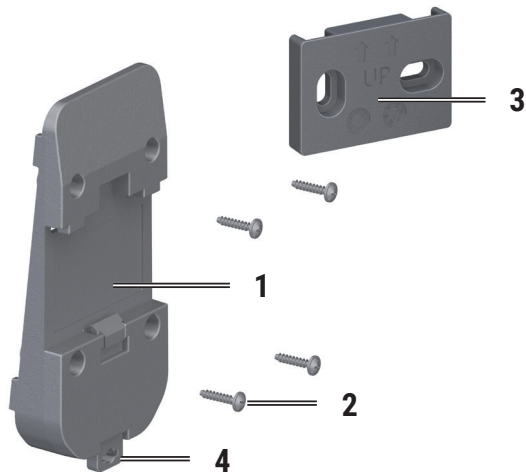

1	AMDS01 Support.
2	4 screws for attaching the support to the AMDS01.
3	Bracket for wall mounting.
4	Hook for securing the support to the DIN rail and wall bracket.

1.2 Technical Features

Usage conditions

Usage:	For use indoors in safe areas.
Temperature:	-5°C .. +45°C
Humidity Range:	5% to 90% RH, non-condensing

Storage

Storage Temperature:	-20°C .. +55°C
Humidity Limit:	5% .. 90% RH

1.3 Mounting the Support on DIN Rail

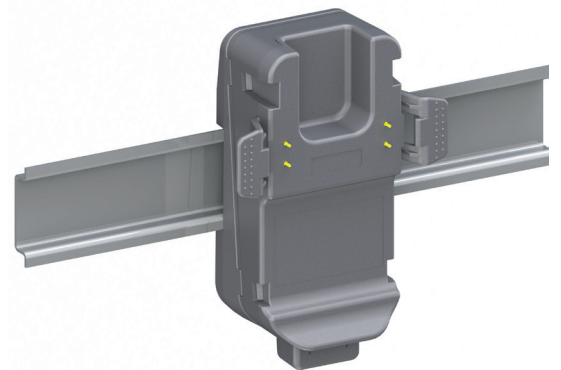
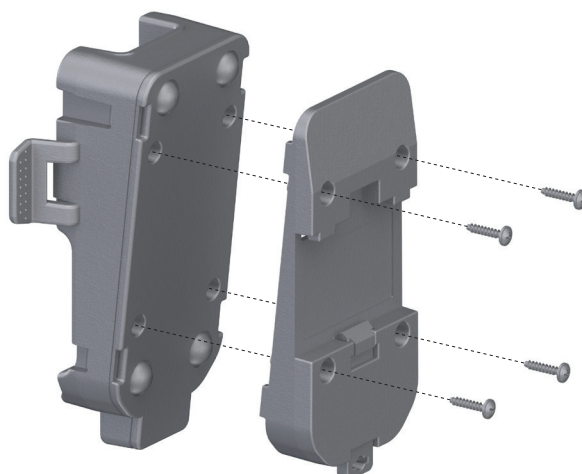

Secure the Support on the DIN Rail Using the Provided Hook

1.4 Wall mounting

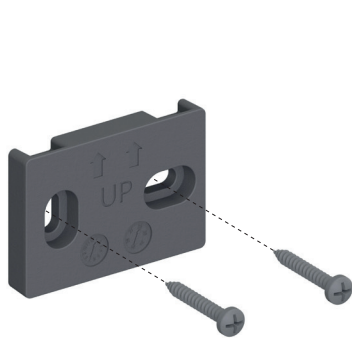
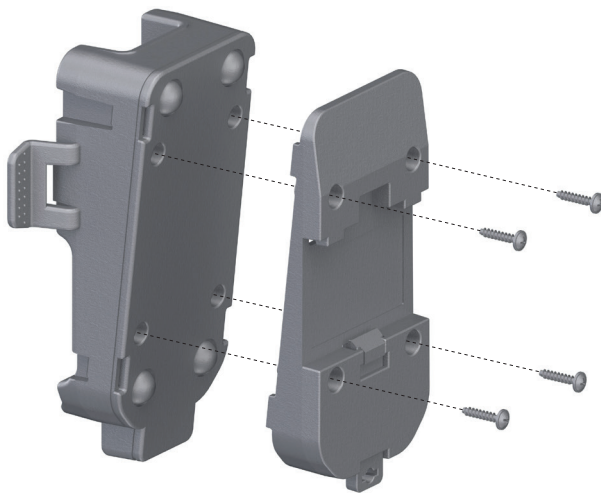

Attach the bracket to the wall with the side of the arrows and UP lettering facing the operator, keeping the arrows pointing upward

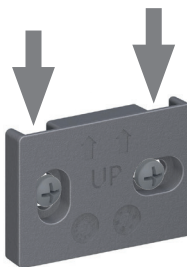

Hook the holder onto the two slots indicated by the arrows

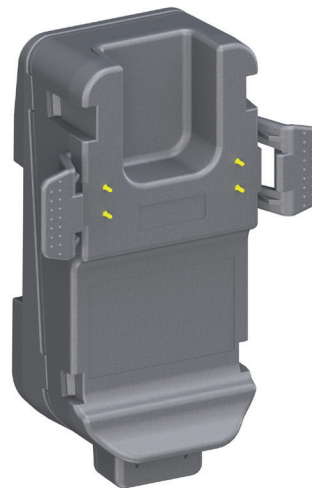

Lock the bracket onto the wall bracket with the appropriate hook.

Seitron S.p.A. a socio unico
Via del Commercio, 9/11 - 36065 - MUSSOLENTE (VI) ITALY
Tel. 0424.567842 - info@seitron.it - www.seitron.com