

# DIGITAL CONTROL UNIT FOR THERMAL SOLAR SYSTEMS

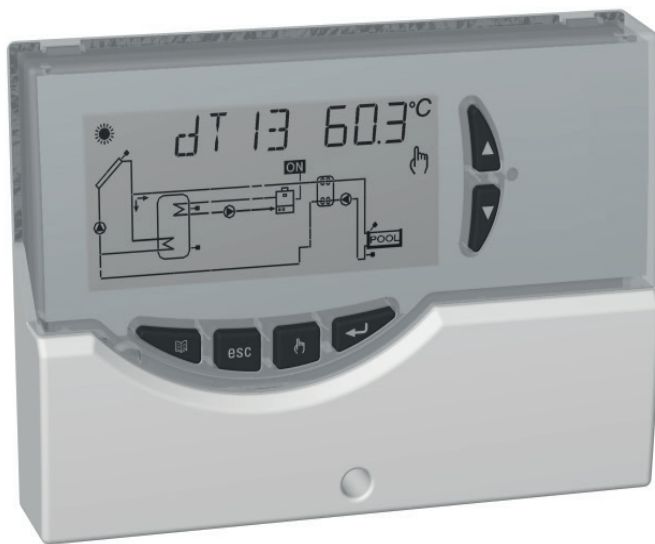

CE



## OVERVIEW

This device is a centralized control unit for thermal solar panels. Supplied with 5 outputs (Load Relays + Alarm Relays), 2 PWM outputs, and 4 Inputs (Probes) it is able to manage a system configuration that can be selected among 20 common types of layouts. When a specific installation is selected, the control unit automatically manages the outputs and inputs used to control the valves, the pumps, the integrative sources and the probes used in the type of installation selected.

Moreover on the backlit LCD display it is possible to visualize the hydraulic diagram of the installation set up, the state of the outputs, the probes as well as several other data and informations.

The power unit permits to reset the factory-set default data; for further information see the parameter P11 'UNIT'.

## DESCRIPTION OF THE KEYS

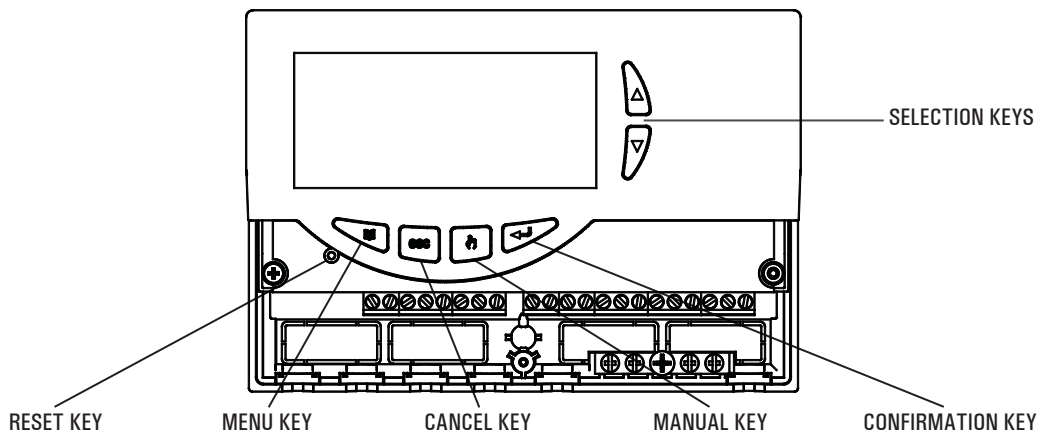

## TECHNICAL FEATURES

Power supply:	230V ~ 50Hz
Power absorption:	4 VA
Sensors type:	4 x Pt1000 Class B DIN
Sensor operating range:	-50 °C .. +200 °C (collector) -50 °C .. +110 °C (Boiler)
Temperature reading range:	-40,0°C .. 260,0°C
Accuracy:	± 1 °C
Resolution:	0,1 °C (0,2 °F)
Offset adjustment:	on S1: ±5.0°C on S2: ±5.0°C on S3: ±5.0°C on S4: ±5.0°C
Installer Password:	0000 .. 9999 (default 0000)
Acoustic Signal:	On/Off (default On)
Backlight timing:	20 sec from last keypress
OUT2 Relay Logic:	NOR=N.O. REV=N.C. non-editable logic for layouts with 2 collectors (default N.O.)
OUT3 Relay Logic:	NOR=N.O. REV=N.C. (default N.O.)
OUT4 Relay Logic:	NOR=N.O. REV=N.C. (default N.O.)
Output relay contacts rating:	
<u>OUT1 - OUT2 - OUT3 - OUT4:</u>	4x2(1)A max 230V ~ (SPST) Voltage free.

Alarm relay contacts rating: 4(1)A max @ 230V ~ (SPDT)  
Voltage free.

### Output Signal:

PWM:	Amplitude:	10V ± 15%
	Frequency:	1KHz
	Corrente:	15mA max.
	Resolution:	0.5%

### Max allowed PWM

cable length: < 5m.  
Protection grade: IP 40

Type of action: 1  
Overvoltage category: II  
Pollution degree: 2  
Tracking index (PTI): 175  
Class of protection against  
electric shock: II 

Rated impulse voltage: 2500V  
Number of manual cycles: 50000  
Number of automatic cycles: 100000  
Software class: A  
EMC test voltage: 230V ~ 50Hz  
EMC test current: 34mA  
Distances tolerances fault  
mode 'short' exclusion: ±0,15mm

Ball pressure test

temperature: 75°C

Operating temp. range: 0°C .. 40°C

Storage temp. range: -10°C .. +50°C

Humidity limits: 20% .. 80% RH non-condensing

Case: Material: ABS V0 self-extinguishing

Color: Signal White (RAL 9003)

Dimensions: 156 x 108 x 47 (W x H x D)

Weight: ~ 723 gr. (version with probe)

~ 553 gr. (version without probe)

Installation: Wall-mount

### **CLASSIFICATION UNDER REG. 2013.811.EC**

Class: not applicable

Contribution to energy efficiency: not applicable

### **AVAILABLE ACCESSORIES AND SPARES**

- Accessories for free contacts: 2 x 230V ~ inputs and 2 free voltage outputs.
- Pt1000 probe -50°C .. +200°C grey cable.
- Pt1000 probe -50°C .. +110°C blue cable.
- Brass pocket 1/2" 7x38mm

## INSTALLATION



### WARNING

The installation technician shall operate in full compliance with all the applicable technical standards in order to grant the unit safety.

### TO INSTALL THE DEVICE, PERFORM THE FOLLOWING OPERATIONS:

- 1 Remove the central screw and the plastic door.

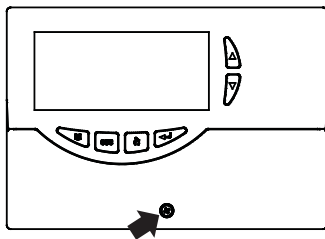

- 2 Remove the two screws shown in the drawing, then remove the whole body from the base.

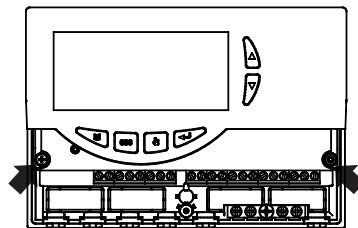

- 3 ASSEMBLY WITH CABLE INPUT ON THE REAR PANEL: if the cable fasteners (delivered with the unit) are not required for installation, use a screwdriver to remove the base blocks permitting the cables to pass through, and fit the blocks delivered (see point 6).

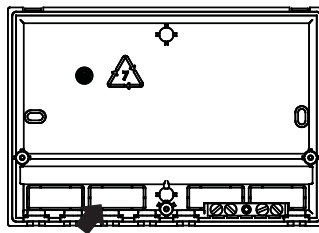

- 4 Fix the power unit base to the wall.

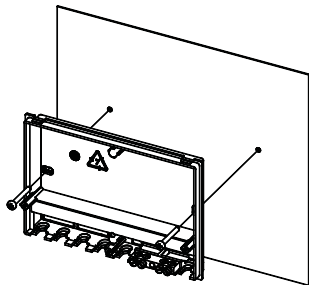

- 5 Fit the cover again with the electronics at the base.

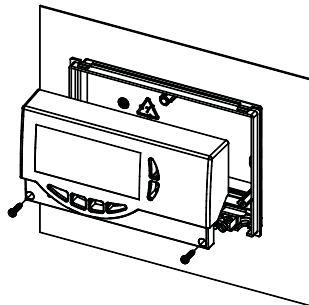

- 6 ASSEMBLY WITH CABLE INPUT ON THE LOWER SIDE: fit the cable fasteners and/or the blocks delivered with the unit.

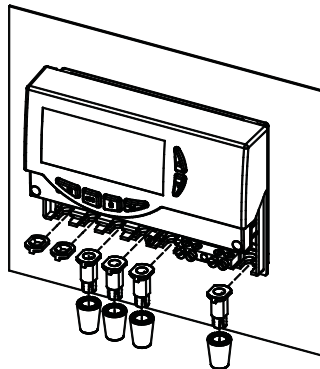

- 7 Make the electrical wiring, according to the following diagram and the examples at page 8 and 9.

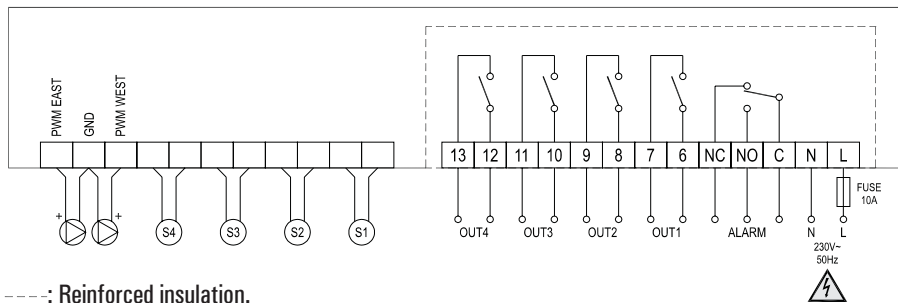

**WARNING!**

Before wiring the appliance be sure to turn the mains power off.

**WARNING!** S1 (or 'COL'), S2, S3 and S4 are Pt1000 temperature sensors. For S1 sensor the  $-50^{\circ}\text{C}..+200^{\circ}\text{C}$  range probe (grey cable) must be used, while the probes with the range of  $-50^{\circ}\text{C}..+110^{\circ}\text{C}$  (blue cable) can be used for the other probes.

When setting up installations with 2 solar panels, the probes corresponding to S1 and S4 **must be exclusively of the  $-50^{\circ}\text{C}..+200^{\circ}\text{C}$  range type**. The relay outputs relative to 1, 2, 3, 4 loads are voltage free; the output of the auxiliary alarm relay is changeover type (SPDT) with voltage free contacts. It is advisable to fit a 10A 250V ~ fuse on the power unit mains capable to intervene in case of short circuits on loads.

**IN ORDER TO CHECK THAT THE DEVICE IS WORKING CORRECTLY IT IS NECESSARY FOR THE LOADS TO BE CONNECTED.**

**TERMINAL BOARD GROUNDING:** On the base of the control unit case is located a brass terminal board for connecting the ground protection conductors of the load devices connected to the control unit.



### Standard example for the placement of the three supplied probes

**S1:** temperature probe with  $-50^{\circ}\text{C}..+200^{\circ}\text{C}$  range (probe supplied with grey cable), to connect it to the collector.

**S2:** temperature probe with  $-50^{\circ}\text{C}..+110^{\circ}\text{C}$  range (probe supplied with blue cable), to connect it to the bottom of the boiler (cold zone)

**S3:** temperature probe with  $-50^{\circ}\text{C}..+110^{\circ}\text{C}$  range (probe supplied with blue cable), to connect it to the upper part of the boiler (hot zone).

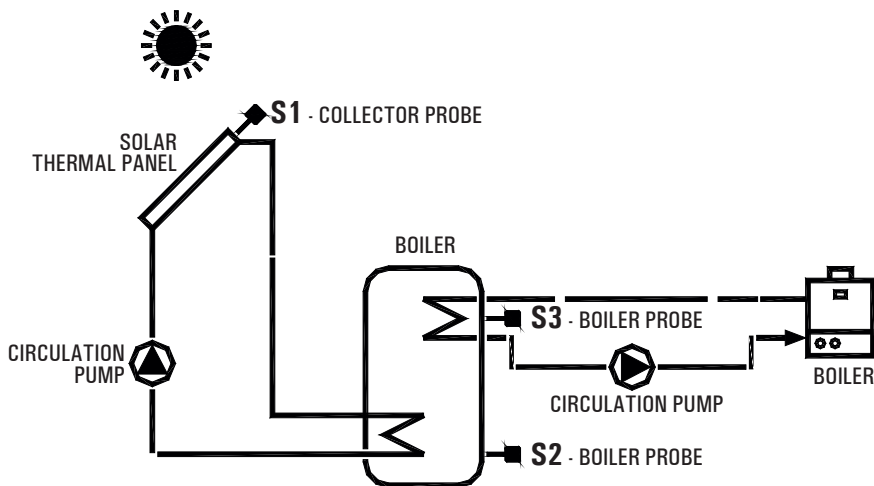

# WIRING EXAMPLE ONLY FOR SOLAR CIRCULATORS IN ACCORDANCE WITH DIRECTIVE ErP 2015 WITH EXTERNAL PWM SIGNAL.

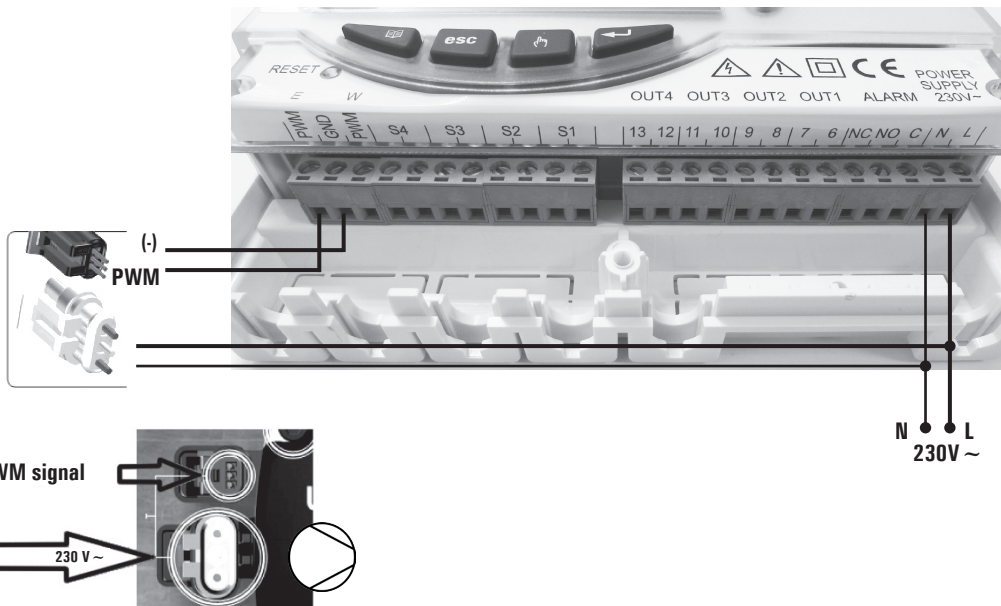

**EXAMPLE OF CONNECTION FOR 3-SPEED SOLAR CIRCULATORS WITH WET or "HIGH EFFICIENCY" ROTOR COMPLIANT WITH DIRECTIVE ErP 2015, WHICH DOES NOT REQUIRE AN EXTERNAL PWM SIGNAL (WITHOUT A CONNECTOR FOR PWM).**

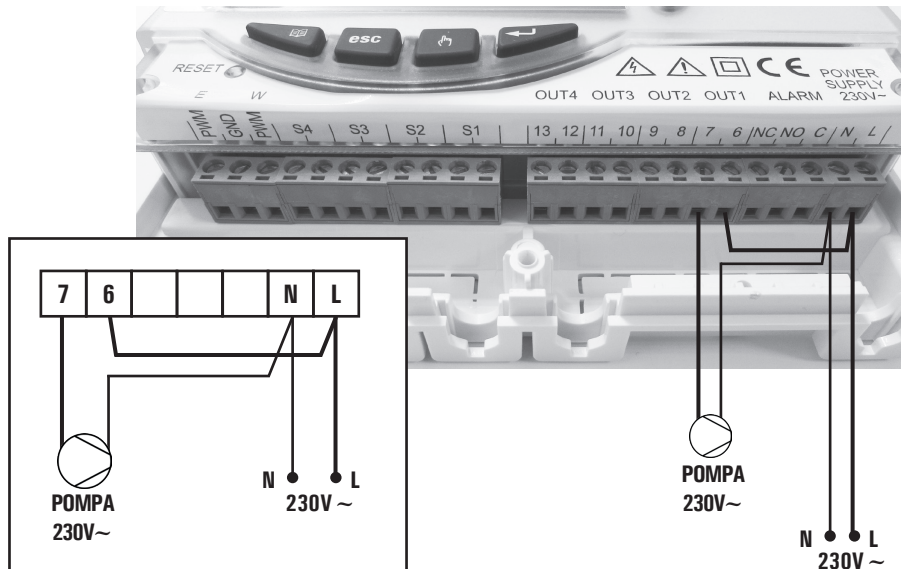

- 8 Fit the door again to close the power unit.

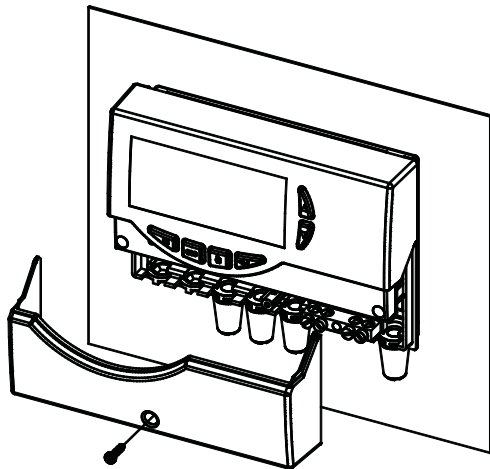

#### **WARNING!**

When closing the unit please ensure that the removable wiring terminals have been inserted with the correct orientation (the terminals screws must be facing upward).

## **STARTING**

### **TURNING ON AND OFF**

To turn the control unit on and off, press the 'esc' key for at least 3 seconds.

When the control unit is turned on it will carry out a diagnosis of the internal circuitry to verify its correct operation and the red led will flash three times.

If the control unit reveals no anomalies the red led will remain on, otherwise it will continue to flash quickly and the display will show the type of error.

### **BACKLIGHT**

By pressing any key the backlight of the display is activated. The backlight automatically shuts off after about 20 seconds from the last key depression.

### **ACOUSTIC SIGNALS**

The control unit is supplied with an internal buzzer that gives the user an acoustic feedback in case of pressure on the keys, alarms and failure.

The acoustic signal can be disabled by properly setting the relevant 'Installer Parameter'.

### **TEST FUNCTION FOR LOAD WIRINGS CHECK**

Through this function, available at the Installer Parameter P7,

the control unit cyclically activates the loads wired to the unit so that the installer can verify the accuracy of the wirings performed.

### DISPLAYING TEMPERATURES AND ENERGY PRODUCED

The device will normally show on the alphanumeric display the temperature measured by the connected probes, the speed (in%) of the collector pumps connected to the PWM (E and W) outputs and the amount of energy produced.

The speed of the PWM pump of the EAST collector is shown on the display with %EFX, while the one of the WEST collector is shown on the display with %WFX.

The display of the energy is expressed in KWh + MWh. The sum of the KWh, once it reaches 1000 KWh will turn to zero and will add 1 the MWh counter.

The total produced energy will be given by the sum of the two counters (for example 815 KWh + 12 MWh = 12,815 MWh). The display of the measured temperatures and the PWM pumps speed is contextual to the hydraulic scheme set by the installer in the P1 parameter.

Pressing the '▲' or '▼' keys you can browse cyclically, through the data, you want to display the value of:

→ S\_1 → S\_2 → S\_3 → S\_4 → %EFX →  
%WFX → KWh → MWh →



### WARNING

The calculation of the produced energy is made depending on the controlled pumps with the ON/OFF switch type command.

If PWM type pumps are connected, the calculation remains valid, but the value is calculated with a round up.

### DISPLAYING SUN / ANTI-FREEZE

During normal operation, the 'SUN' icon will be always lit on the display. When the power unit detects a condition which forces the manifold pump to get started, the 'SUN' icon will be flashing.

When the Anti-freeze function is activated, both 'SUN' and 'SNOW' icons will be lit; when the power unit detects a temperature which forces the anti-freeze function to get started, the 'SNOW' icon will also be flashing.

### AUTOMATIC/ABC (Automatic Boiler Control)

The control unit can manage the selected plant in 2 different modes:

#### AUTOMATIC (Unit operating normally)

In this mode, the unit automatically manages and controls the

operation of the system according to the set up data.

### **ABC (Automatic Boiler Control)**

By pressing the 'h' button you can enable or disable the function ABC of the control unit.

When the 'ABC' function is activated, the display will light up the 'h' icon.

**The following conditions activate the EAST collector pump:**

$S_1 \geq TABC + \text{hysteresis' value}$

and

$S_1 \geq S_2 + \text{hysteresis' value}$

The following conditions switch off the collector pump:

$S_1 < TABC$

or

$S_1 < S_2$

**The following conditions activate the WEST collector pump:**

$S_4 \geq TABC + \text{hysteresis' value}$

and

$S_4 \geq S_2 + \text{hysteresis' value}$

The following conditions switch off the collector pump:

$S_4 < TABC$

or

$S_4 < S_2$

Where:

**S\_1:** Temperature measured by the collectorprobe (EAST).

**S\_2:** Temperature measured by the boiler probe.

**S\_4:** Temperature measured by the collectorprobe (WEST).

**TABC:** Temperature set in the installer parameter P2.

**Hysteresis value of the ABC function:** 3.0 °C (fixed and unchangeable).

The only active controls will be those relating to the maximum and safety temperatures.

### **RESET**

In order to reset the device, press the key labelled as 'RESET' located behind the removable door; **DO NOT USE PINS OR NEEDLES.**

## INSTALLER PARAMETERS

To access the installer parameters press the '↵' key.

### Entering the Password

The display will show 'PWD 0000' with the leftmost digit flashing thus requesting for the correct password.

In order to set the 4 password digits use the '▲' or '▼' key; by pressing the '↵' key, the current digit is confirmed and the flashing is transferred to the following digit.

After confirming the last digit, the '↵' key will give access to the installer parameters.

**The initial password is factory set as '0000'.**

### Modifying the Password

In order to modify the stored password, first press the '↵' key, then proceed as follows:

PRESS THE 'MENU' KEY.

THE DISPLAY SHOWS 'PWDH0000'.

ENTER THE CURRENT PASSWORD.  
(same procedure described above)

THE DISPLAY SHOWS 'PWDN0000'.

INSERT THE NEW PASSWORD.

THE DISPLAY SHOWS 'PWDC0000'.

INSERT NEW PASSWORD.

THE CONTROL UNIT WILL MEMORIZE THE NEW PASSWORD  
AND GIVE ACCESS TO THE INSTALLER PARAMETERS.

Pressing the 'esc' key at any time will exit the password management mode.

### **Using installer parameters**

Inserting the correct Password gives access to the installer parameters change mode ( ' SET ' icon lights). The first information displayed is the model of the control unit in use and the parameter ' P1 ' value.

By pressing the ' ▲ ' or ' ▼ ' keys it is possible to scroll through the various parameters.

Pressing the ' ← ' key takes the user to the parameter modifying mode selected.

To exit the installer mode press the ' esc ' key or wait 20 seconds.



#### **WARNING!**

**In the ' installer parameters ' mode all the outputs are disabled.**

**All default values are to be considered as indicative, being they subject to changes due to the version and without prior notice.**

PRESS THE ' ← ' KEY ON THE START PAGE.



THE DISPLAY SHOWS ' PWD 0000 '.



INSERT THE CURRENT PASSWORD.



THE DISPLAY SHOWS THE FIRST  
' INSTALLER PARAMETER '.





USING THE ARROWS '▲' or '▼' IT IS POSSIBLE TO CYCLICALLY SCROLL THROUGH THE INSTALLATION PARAMETERS:

<b>P1:</b> SELECTION INSTALLATION TYPE	'SCH'
<b>P2:</b> SETTING THERMAL DATA	'DATA'
<b>P3:</b> ANTIFROST PARAMETERS MANAGEMENT	'O AF'
<b>P4:</b> ACOUSTIC SIGNAL MANAGEMENT	'BEEP'
<b>P5:</b> LOGIC RELAY SELECTION	'ACT'
<b>P6:</b> INTEGRATION HOURS COUNTER	'C AH'
<b>P7:</b> LOADS WIRING TEST	'TEST'
<b>P8:</b> CALCULATION OF THE ENERGY PRODUCED	'SEM'
<b>P9:</b> RECOOLING FUNCTION	'REF'
<b>P10:</b> PERIODIC ACTIVATION OF LOADS	'PVK'
<b>P11:</b> MEASUREMENT UNIT	'UNIT'
<b>P12:</b> LIMITATION OF COLLECTOR MINIMUM TEMP.	'MTL'
<b>P13:</b> PWM OUTPUT SETTING	'ERP'
<b>P14:</b> COLLECTOR'S RESET TEMPERATURE	'SAFE'
<b>P15:</b> VACUUM PIPES	'VTC'
<b>P16:</b> ANTI-LEGIONELLA	'LEG'

PRESS THE '←' KEY TO MODIFY THE SELECTED PARAMETER.



CONFIGURE DATA FOR EVERY SINGLE PARAMETER AS EXPLAINED BELOW.



PRESS THE 'esc' KEY TO RETURN TO THE INSTALLER PARAMETERS SELECTION.



WAIT 20 SECONDS OR PRESS THE 'esc' KEY TO EXIT THE INSTALLER MODE.



## P1: SELECT INSTALLATION TYPE

Pressing the '▲' or '▼' keys will show all the installations that can be set up (if the probe for the selected installation has a problem or is left unconnected, that probe will flash on the display). To confirm the selected installation press the '←' key; the control unit will memorize the choice and the display will again show the parameter list.

To cancel the selection, press the 'esc' key. In this case the control unit will abandon the changes made and will show again the parameter list.

The parameters influencing the regulation of the selected setup are listed in the following and can be modified through the second installer parameter (P2).



### WARNING!

When going into parameter P1, the controller will reset the maximum temperatures (MT) detected until that moment. Furthermore, when quitting this parameter, the controller will set again the temperature display on the sensor S\_1.

The thermal parameters to be set are displayed when the relevant scheme is selected, this means the power unit will only display the thermal parameters actually activated for the selected hydraulic scheme.

## List of thermal data to be eventually programmed

PARAMETERS	DESCRIPTION
TS1-TS2-TS3-TS4	Probe safety temperature
ΔT 12	Differential between the probes S1-S2
ΔT 13	Differential between the probes S1-S3
ΔT 14	Differential between the probes S1-S4
ΔT 34	Differential between the probes S3-S4
ΔT 42	Differential between the probes S4-S2
ΔT 43	Differential between the probes S4-S3
MTC	Adjustment of collector minimum temperature
MTEN	Enabling/disabling the collector minimum temperature
TM2	Maximum temperature of the probe S2
TM3	Maximum temperature of the probe S3
TM4	Maximum temperature of the probe S4
TAH	Integration temperature on the probe S3
MOD	Integration functioning modes
TEC	Economy temperature on S3 probe
HY12	Hysteresis of ΔT 12
HY13	Hysteresis of ΔT 13
HY14	Hysteresis of ΔT 14
HY34	Hysteresis of ΔT 34
HY42	Hysteresis of ΔT 42
HY43	Hysteresis of ΔT 43
HYT	Thermostatic hysteresis
HYTS	Safety thermostatic hysteresis

## CONTROL LOGIC

**WARNING:** The following control logics must be applied to all the diagram described hereinafter.

### CONTROL LOGIC IN ABC

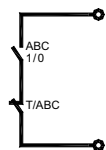

The control logic of the 'ABC' function actually replaces the differential control. The checks on the Maximum and Safety temperatures are always kept active. The integrative source is switched off when ABC mode is active. Once ABC mode is turned off the integrative source will be automatically activated.

### CONTROL LOGIC OF THE SAFETY THERMOSTATS

If an alarm turns on because of an overcoming of the safety temperature, the alarm relay will be activated. While the loads outputs will keep on functioning according to the relative logics. In this conditions, the control unit emits a beeping audio

signal and on the display will flash the icon "⚠". The control is not active with the control unit in "OFF" mode (the display shows the message OFF).

### **Condition for the alarm relay activation**

The logic of the functioning of the alarm relay , always present in every diagram selected, runs with the following conditions:

$TX \geq TS$  = Alarm relay ON

$TX \leq (TS - \text{hysteresys})$  = Alarm relay OFF

Where:

TX: Temperature picked up by the connected sensors (S1 .. S4).

TS: Safety temperature related to the sensors (S1 .. S4).

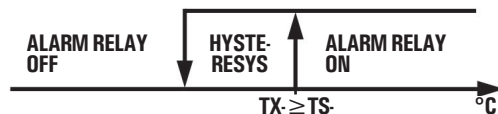

### Control logic

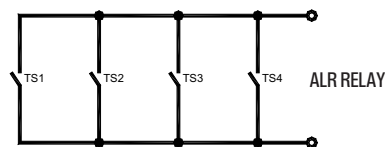

## AVAILABLE DIAGRAMS

### SCH 01

Solar heating installation with 1 tank and no integrative heat source.

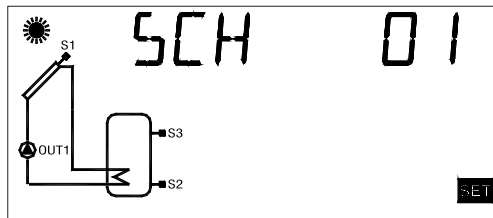

#### Control logic

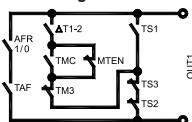

### SCH 02

Solar heating installation with 1 tank and additional thermostatic heating.

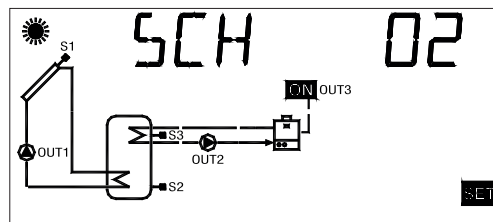

#### Control logic

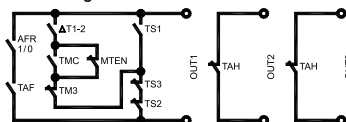

## SCH 03

Pool solar heating installation.

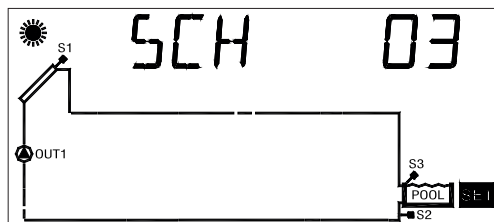

### Control logic

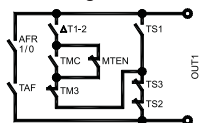

## SCH 04

Solar heating installation with 1 tank, direct integration by means of valve logic.

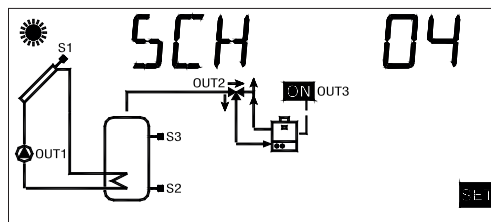

### Control logic

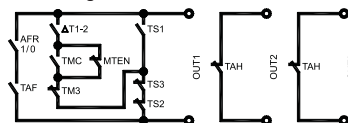

## SCH 05

Natural circulation solar heating installation with 1 tank and direct integration by means of valve logic.

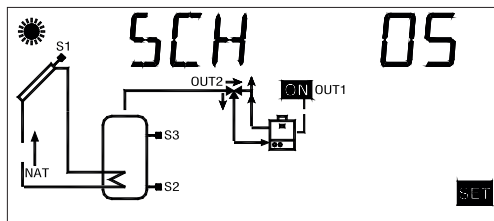

### Control logic

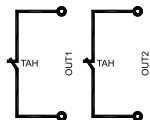

## SCH 06

Solar heating installation with 2 tanks, valve logic control and no integrative heat source.

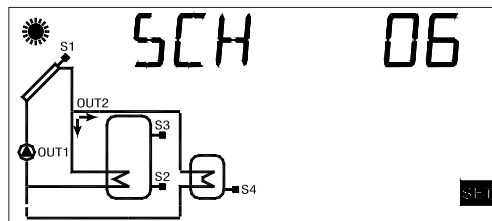

### Control logic

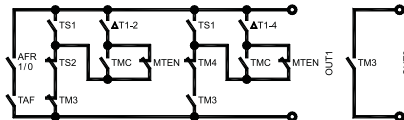

## SCH 07

Solar heating installation with 2 tanks, logic valve control, and integrative heat source.

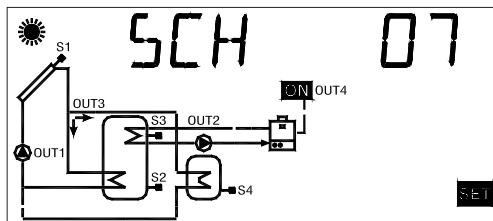

### Control logic

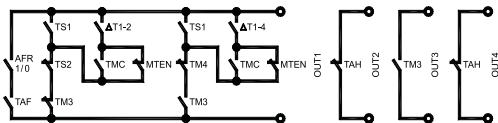

## SCH 08

Solar heating installation with 2 tanks, valve logic control, no integrative heat source.

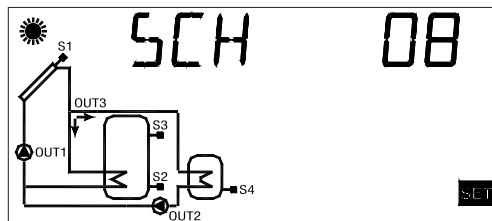

### Control logic

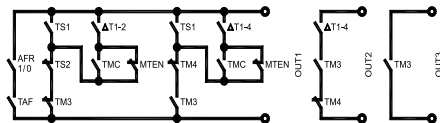

## SCH 09

Solar heating installation with 1 tank, valve logic control and heat exchanger for pool heating.

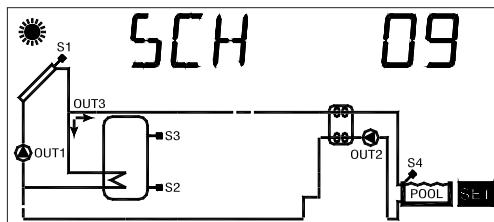

### Control logic

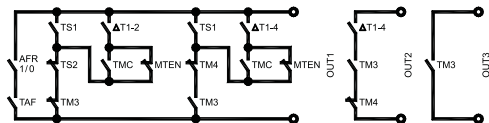

## SCH 10

Solar heating installation with 2 tanks, sanitary regulation with thermal exchange and integrative heat source.

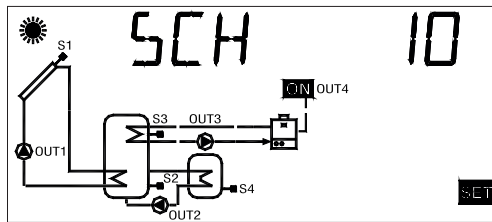

### Control logic

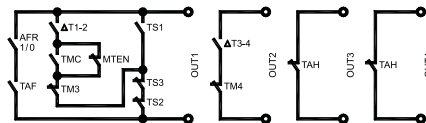



## SCH 11

Solar heating installation with 1 tank and additional heat source with solid fuel.

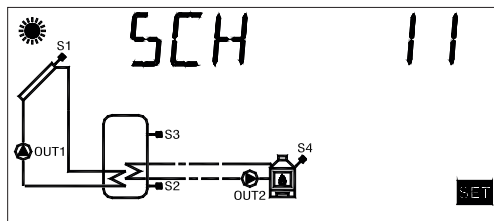

## SCH 12

Solar heating installation with 1 tank plus one integrative and one solid fuel heat sources.

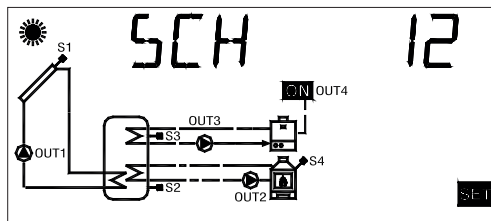

### Control logic

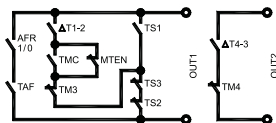

### Control logic

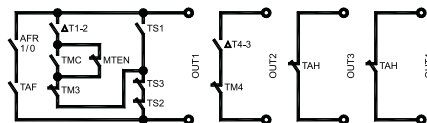

## SCH 13

Solar heating installation with 2 tanks, pump logic.

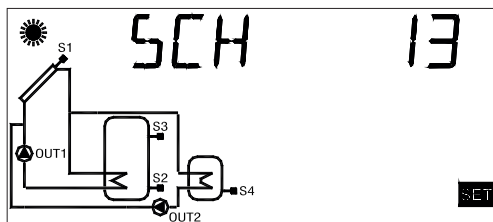

## SCH 14

Solar heating installation with 3 tanks, pump logic.

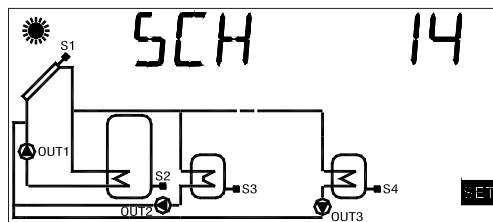

### Control logic

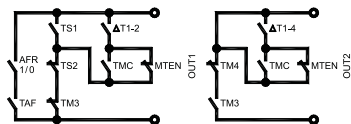

### Control logic

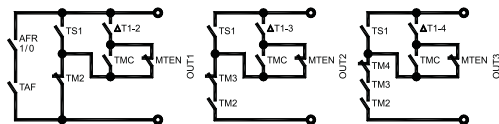

## SCH 15

Solar heating installation EAST / WEST, 1 tank and no integrative heat source.

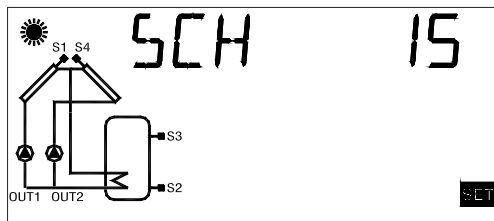

## SCH 16

Solar heating installation EAST / WEST, 1 tank and integrative heat source.

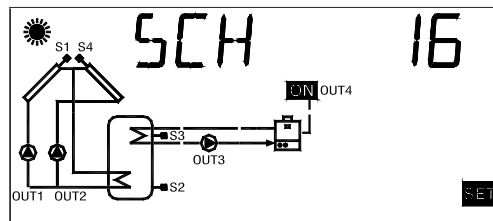

### Control logic

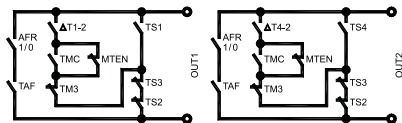

### Control logic

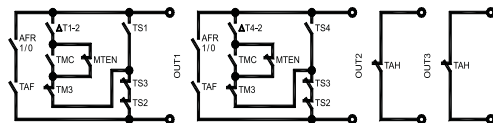

## SCH 17

Solar heating installation EAST / WEST, 1 tank, integrative heat source by means of valve logic.

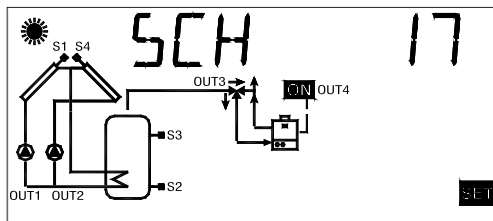

### Control logic

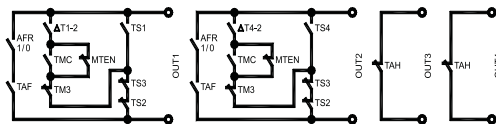

## SCH 18

Solar heating installation with 2 tanks, logic valve, integrative heat source, extra pump on the second boiler.

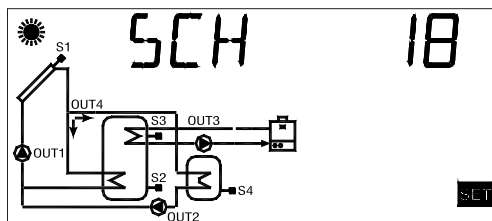

### Control logic

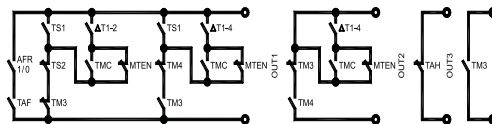

## SCH 19

Solar heating installation with 1 tank, logic valve, integrative heat source and heat exchanger for pool heating.

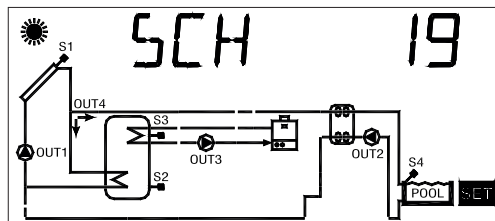

### Control logic

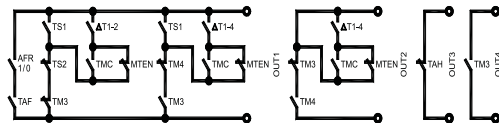

## SCH 20

Solar heating system with 1 tank, 2 sensors only and supplemental heating excluded.

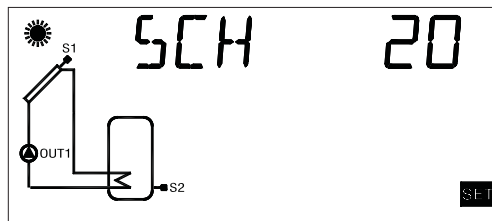

### Control logic

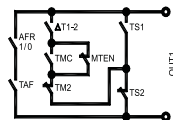

## P2: SETTING THE THERMAL DATA

Using this parameter it is possible to set the thermal data related to the selected installation:

**The control unit is supplied with pre-programmed thermal data for optimal operation. Any change to these values must be performed by qualified personnel only.**

AFTER SELECTING PARAMETER P2 PRESS THE '←' KEY.

USING THE ▲ ' or ' ▼ ' ARROWS IT IS POSSIBLE TO SCROLL CYCLICALLY THROUGH THE THERMAL DATA:

- Safety temperatures
- Differentials
- Hysteresis of the differentials
- Hysteresis of the safety thermostats
- Hysteresis of the thermostats
- Offset
- Maximum temperatures
- Integration Temperature on probe S3
- Integration functioning modes
- Economy temperature on S3 probe
- ABC (Automatic Boiler Control) temperature

PRESS THE '←' TO MODIFY THE THERMAL DATA SELECTED; THE DATA WILL START FLASHING.

SET THE DESIRED NUMERIC VALUE USING THE '▲' or '▼' ARROWS.

PRESS THE '←' KEY TO CONFIRM THE PROGRAMMED SETTINGS OR PRESS THE 'esc' KEY TO CANCEL THE CHANGES.

In the following the regulation ranges allowed for each parameter are listed.



### WARNING!

The thermal parameters to be set are displayed when the relevant scheme is selected, this means the power unit will only display the thermal parameters actually activated for the selected hydraulic scheme.

Safety temperatures		
Data	Regulation range	Default
TS1	60.0 .. 240.0 °C	140.0 °C
TS2	40.0 .. 90.0 °C	90.0 °C
TS3	40.0 .. 90.0 °C	90.0 °C
TS4 <sup>1</sup>	40.0 .. 90.0 °C	90.0 °C
TS4 <sup>2</sup>	60.0 .. 240.0 °C	140.0 °C



#### WARNING!

If the selected scheme has only one manifold, the default value of the safety temperature (TS4) will be 90°C (!); if the selected scheme has two manifolds, the default value of the safety temperature (TS4) will be automatically set at 140°C (?).

When changing from a two-manifold scheme to one-manifold scheme and the maximum temperature (TM4) is higher or equal to 85°C, the safety temperature (TS4) will be automatically limited to the value TM4 + 5°C.

It is not possible to set the Safety Temperatures TS2, TS3, TS4 to a value lower than the relevant Maximum Temperature, as the value of the Safety Temperature is

limited to the value of the Maximum Temperature + 5°C. To lower the Safety Temperature, it is first necessary to decrease the Maximum Temperature and then set the Safety Temperature to the desired value.

If the Safety Temperature is displayed but the relevant Maximum Temperature is not, then the Safety Temperature will be limited according to the highest Maximum Temperature operating in the current scheme (i.e. in scheme no.6, the value of the TS2 safety temperature will be limited according to the value of the TM3 maximum temperature if this is higher than TM4).

Should the hydraulic scheme be changed and SCH5 scheme previously activated, all the Safety and Maximum temperatures will be set at the factory-set default values

Differential		
Data	Regulation range	Default
ΔT12	1.0 .. 25.0°C	8.0 °C
ΔT14	1.0 .. 25.0°C	6.0 °C
ΔT34	1.0 .. 25.0°C	6.0 °C
ΔT43	1.0 .. 25.0°C	6.0 °C
ΔT42	1.0 .. 25.0°C	8.0 °C
ΔT13	1.0 .. 25.0°C	6.0 °C

**WARNING!**

It is not possible to set the Differential to a value lower than the relevant hysteresis because the value of the Differential is limited to the value of the hysteresis + 1°C. To lower the Differential it is first necessary to decrease the value of the hysteresis.

Hysteresis of the differentials		
Data	Regulation range	Default
HY12	0.5 .. 20.0°C	4.0 °C
HY14	0.5 .. 20.0°C	2.0 °C
HY34	0.5 .. 20.0°C	2.0 °C
HY43	0.5 .. 20.0°C	2.0 °C
HY42	0.5 .. 20.0°C	4.0 °C
HY13	0.5 .. 20.0°C	2.0 °C

**WARNING!**

It is not possible to set the Hysteresis (HY) to a value higher than the relevant Differential ( $\Delta T$ ), because the value of the hysteresis is limited to the value of the Differential -1°C. To increase the value of the

Hysteresis it is first necessary to increase the value of the Differential ( $\Delta T$ ).

Hysteresis of the safety temperatures		
Data	Regulation range	Default
HYTS	1.0 .. 15.0°C	2.0 °C

Thermostatic hysteresis		
Data	Regulation range	Default
HYT	1.0 .. 15.0°C	2.0 °C

Probe Offset		
Data	Regulation range	Default
OS1	-5.0 .. +5.0°C	0.0 °C
OS2	-5.0 .. +5.0°C	0.0 °C
OS3	-5.0 .. +5.0°C	0.0 °C
OS4	-5.0 .. +5.0°C	0.0 °C

Maximum temperature of the probes		
Data	Regulation range	Default
TM2	20.0 .. 90.0°C	70.0 °C
TM3	20.0 .. 90.0°C	70.0 °C
TM4	20.0 .. 90.0°C	70.0 °C



**WARNING!**

It is not possible to set the Maximum Temperature (TM) to a value higher than the relevant Safety Temperature, as the Maximum Temperature value is limited to the value of the Safety Temperature (TS) -5°C. To increase the Maximum Temperature value, it is first necessary to increase the value of the Safety Temperature.

Integration Temperature (After Heating) on probe S3		
Data	Regulation range	Default
TAH	(TEC + 3) / 20°C .. (TM3 - 5)°C	50.0 °C

**WARNING!**

If the parameter related to the setting of the MOD integration functioning mode has been set on nOr, it won't be possible to set the value of the integration Temperature TAH to a value higher than the Maximum Temperature TM3 minus 5°C.

While, if the parameter related to the setting of the MOD integration functioning mode has been set on ECO, it

won't be possible to set the value of the TAH integration Temperature to a value lower than the Economy TEC Temperature plus 3°C and to a value higher than the one of the Maximum Temperature TM3 minus 5°C.

As the value of the integration temperature TAH is bonded to the value of the maximum temperature TM3 minus 5°C and to the value of the Economy temperature plus 3°C (if MOD set on ECO), if it is necessary to diminish the value of the TM3 maximum temperature lower than the value of the set TAH integration temperature it will be necessary to diminish the value of the TAH integration temperature first and later modify the Maximum Temperature TM3.

The same consideration is valid if it is wanted to increment the value of the TEC Economy Temperature to an higher value than the set TAH integration temperature; first, it is needed to increment the value of the TAH integration temperature and then act on the Economy TEC Temperature.

Hysteresis value TAH

MOD set to nOr:

MOD set to ECO:

See HYT settings

The value of the hysteresis is fixed to 1°C (not settable).



numeric value, some dashes will appear.

It won't be possible to set the value TEC Economy Temperature to an higher value than the TAH integration temperature minus 3°C.

As the TEC Economy value is bonded to the value of the TAH integration temperature minus 3°C, in case it is wanted to diminish the value of the TAH integration temperature under the set TEC Economy Temperature it will be necessary to first lower the TEC Economy Temperature value and then act on the TAH Integration Temperature.

#### ABC Temperature (Automatic Boiler Control) on probe S3

Data	Regulation range	Default
TABC	20.0 .. 80.0°C	30.0 °C

### P3: ANTIFROST PARAMETER MANAGEMENT

Using this parameter it is possible to set the data managing the antifrost function.



#### WARNING!

The control unit is supplied with preset antifrost data for optimal operation.

Any change to these values must be performed by qualified personnel only.

AFTER SELECTING PARAMETER P3 PRESS  
THE ' ← ' KEY.



IT IS POSSIBLE TO SCROLL CYCLICALLY THROUGH  
ANTIFROST DATA USING THE ' ▲ ' or ' ▼ ' ARROWS:

- Antifrost temperature ' TAF '
- Collector pump ignition interval ' P ON '
- Collector pump shut off interval ' P OFF '
- Antifrost test duration ' TMR '



PRESS THE '←' KEY TO MODIFY THE THERMAL DATA SELECTED; THE DATA WILL START FLASHING.



USE THE '▲' or '▼' ARROWS TO SET THE DESIRED NUMERIC VALUE.



PRESS THE '←' KEY TO CONFIRM THE PROGRAMMING OR PRESS THE 'esc' KEY TO CANCEL THE CHANGES.



BY PRESSING THE '←' KEY AFTER MODIFYING THE DATA RELATIVE TO THE DURATION OF THE ANTIFROST TEST, THE CONTROL UNIT WILL CONFIRM THE DATA AND WILL START THE TEST.

In the following the regulation ranges allowed for each parameter are listed.

<b>Antifrost temperature</b>		
Data	Regulation range	Default
TAF	-10.0°C .. +5.0°C	4.0 °C

<b>Collector pump 'on' time</b>		
Data	Regulation range	Default
P ON	5 .. 60 sec.	10 sec.

<b>Collector pump 'off' time</b>		
Data	Regulation range	Default
P OF	1 .. 60 min.	20 min.

<b>Antifrost test duration</b>		
Data	Regulation range	Default
TMR	5 .. 60 sec.	10 sec.

#### **P4: ACOUSTIC SIGNAL MANAGEMENT**

Using this parameter it is possible to enable or disable the acoustic signalling of the control unit (keyboard tones, alarms, and diagnostics).

In the following the regulation ranges allowed for each parameter are listed.

<b>Enable (1) / Disable (0) acoustic signal</b>		
<b>Data</b>	<b>Regulation range</b>	<b>Default</b>
BEEP	Off .. On	On

**Note:** 'Off' disables it, while 'On' enables acoustic signalling.

#### **P5: RELAY LOGIC SELECTION**

Using this parameter it is possible to reverse the output logic from Normally Open (N.O.) to Normally Closed (N.C.) and vice-versa. It is only possible to modify the output logic for the relays actually active in the selected setup.

Value '1' for these parameters means that the output logic is reset to the N.O. value (default).

**If the parameter is not activated in the selected scheme, the message ' NONE ' will appear on the display.**

AFTER SELECTING PARAMETER P5 PRESS  
THE ' ← ' KEY.



USING THE ' ▲ ' or ' ▼ ' ARROWS IT IS POSSIBLE TO  
SCROLL THROUGH THE ACTIVE OUTPUTS.



SELECT THE DESIRED OUTPUT AND  
PRESS THE '←' KEY.



CHANGE THE OUTPUT LOGIC USING  
THE '▲' or '▼' ARROWS.



PRESS THE '←' KEY TO CONFIRM THE PROGRAMMED  
SETTING OR PRESS THE 'esc' KEY TO CANCEL THE  
MODIFICATION.

The user is allowed to select the relay logic for max. 3 outputs  
only, listed in the following.

Output logic for OUT 2		
Data	Regulation range	Default
OUT 2	0 .. 1	1

Output logic for OUT 3		
Data	Regulation range	Default
OUT 3	0 .. 1	1

Output logic for OUT 4		
Data	Regulation range	Default
OUT 4	0 .. 1	1

**Note: '0' means Normally Closed (N.C.) logic, while '1'  
means Normally Open (N.O.) logic.**

## P6: INTEGRATION HOURS COUNTER

Using this parameter it is possible to display the actual number of hours of the integrative source operation or reset it.

AFTER SELECTING PARAMETER P6 PRESS THE '↵' KEY.



THE DISPLAY SHOWS 'H' AND ACTUAL HOURS OF ACTIVITY OF THE INTEGRATIVE SOURCE.



PRESS THE '↵' KEY, THE DISPLAY SHOWS 'H' FLASHING.



PRESSING THE '↵' KEY RESETS THE COUNTER, PRESSING THE 'esc' AGAIN SHOWS THE CURRENT RUNNING HOURS.

The counter recording the running hours of the integrative source can handle values up to 9999. Once the maximum value is reached the counter stops.

## P7: LOADS WIRING TEST

This parameter allows to set the test of the loads wired to the control unit as well as the wirings themselves.

Depending on the configured scheme, the power unit will activate the loads connected by sequentially activating all the available outlets for 10 seconds each, including the alarm relay and its buzzer.

The number of times for which the entire test is repeated, in multiples of 5, can be set using the single 'TMR' parameter present. The activation of the test is signalled on the display with the 'TIMER' icon.



### WARNING

The activation of the alarm relay will be shown on the display by the flashing 'TIMER' icon and the activation of the buzzer also in order to test the acoustic signals emission.

AFTER SELECTING PARAMETER P7 PRESS THE '↵' KEY.



THE DISPLAY SHOWS 'TMR' AND THE NUMBER OF CYCLES IN THE TEST.



PRESS '←'. THE DISPLAY SHOWS 'TMR' FLASHING.



USING THE KEYS '▲' or '▼' SET THE NUMBER OF CYCLES TO 5, 10, 15, 20 OR 25.



PRESS '←' TO CONFIRM THE PROGRAMMED DATA AND START THE TEST. BY PRESSING 'esc' THE MODIFICATIONS ARE CANCELED AND THE DISPLAY AGAIN SHOWS THE NUMBER OF PRESET CYCLES.

Test sequence setting		
Data	Regulation range	Default
TMR	05 .. 25	05

## P8: CALCULATION OF THE ENERGY PRODUCED

This parameter permits to manage the data concerning the measurement of the Heat quantity produced by the plant. The quantity of energy produced will be stored in the power unit storage every 2 hours approx.

If the flow value being stored is zero, the message 'FLOW OFF' will appear on the display and the energy counting will be deactivated.

Select 'RESET' and press 'ENTER' to reset the counter of the energy produced.

**If the parameter is not activated in the selected scheme, the message 'NONE' will appear on the display.**

AFTER SELECTING PARAMETER P8 PRESS THE '←' KEY.



PRESS ARROWS '▲' or '▼' TO CYCLICALLY SCROLL THE PARAMETERS FOUR COUNTING THE ENERGY PRODUCED:

Plant flow rate in litres/minute 'FLOW'  
Reset of produced energy counters 'RST'





PRESS '←' TO CHANGE THE SELECTED PARAMETER;  
THE PARAMETER WILL START BLINKING.



PRESS ARROWS '▲' and '▼' TO SET  
THE DESIRED VALUE (for 'FLOW' parameter only).



PRESS THE '←' KEY TO CONFIRM THE  
PROGRAMMING OR PRESS THE 'esc' KEY TO CANCEL  
THE CHANGES.

#### Plant flow rate expressed in litres/minute

Data	Regulation range	Default
FLOW	OFF .. 20.0 l/min.	2.3 l/min.

## P9: RECOOLING FUNCTION

This function permits to automatically reduce the boiler temperature.

This parameter permits to set the data concerning the management of the automatic cooling function of the boiler. The icons of 'pump' and 'sun' flashing on the display will indicate that the manifold pump cooling the boiler has been activated.

The Recooling function will be activated if the RCEN parameter is 1, whereas it will be deactivated if the parameter is 0.

**If the parameter is not activated in the selected scheme, the message 'NONE' will appear on the display.**

AFTER SELECTING PARAMETER P9 PRESS  
THE '←' KEY.



PRESS ARROWS '▲' or '▼' TO CYCLICALLY SCROLL  
THE RECOOLING FUNCTION PARAMETERS:

Recooling Temperature	' TR '
Recooling Temperature Differential	' ΔTR '
Recooling function enabling	' RCEN '



PRESS ' ← ' TO CHANGE THE SELECTED PARAMETER;  
THE PARAMETER WILL START BLINKING.



PRESS ARROWS ' ▲ ' and ' ▼ ' TO SET  
THE DESIRED VALUE.



PRESS THE ' ← ' KEY TO CONFIRM THE  
PROGRAMMING OR PRESS THE ' esc ' KEY TO CANCEL  
THE CHANGES.

Recooling Temperature		
Data	Regulation range	Default
TR	70°C .. (TM3+5)°C	70°C



#### WARNING!

It is not possible to set the value of the Recooling Temperature (TR) at a value which is equal or lower than the value of the highest Maximum Temperature.

The value of the Recooling Temperature (TR) is linked to the value of the highest Maximum Temperature + 1°C. In order to lower the Recooling Temperature (TR) below the value of the maximum Temperatures already set, first of all lower the value of the maximum Temperature(s), then change the Recooling Temperature (TR). Should any Maximum Temperature be increased to a value which is higher than the value of the Recooling Temperature (TR), this is automatically set at the value of the highest maximum temperature + 1°C. The same shall be considered as regards the Recooling Temperature (TR) with reference to the integration temperature (TAH).

#### Recooling Temperature (TR) Differential

Data	Regulation range	Default
ΔTR	6°C .. 15°C	8°C

#### Activation / Deactivation of the Recooling function

Data	Regulation range	Default
RECEN	0 .. 1	1

Note: ' 0 ' indicates the Recooling function is deactivated, whereas ' 1 ' indicates it is activated.

## P10: PERIODIC ACTIVATION OF LOADS

This parameter permits to manage the periodic activation of loads (pumps and valves) included in the hydraulic scheme selected. In particular, if a load has not been activated in 21 hours' time, it will be automatically activated by the power unit for 15 seconds, according to the operation logic.

If a load is activated during this time gap, the counting will start again from zero.

The timers counting the waiting and activation time will not be stored, and counting will start again from zero in case of reset or voltage lack.

The 'periodic activation of loads' function will be activated if the PVK parameter is 1, whereas it will be deactivated if the parameter is 0.

AFTER SELECTING PARAMETER P10 PRESS  
THE '←' KEY.

THE DISPLAY SHOWS 'PVK'.

PRESS '←'. THE DISPLAY  
SHOWS 'PVK' FLASHING.

PRESS ARROWS '▲' and '▼' TO SET  
THE DESIRED VALUE.

PRESS THE '←' KEY TO CONFIRM THE  
PROGRAMMING OR PRESS THE 'esc' KEY TO CANCEL  
THE CHANGES.

### Periodic activation of loads

Data	Regulation range	Default
PVK	0 .. 1	1

**Note:** '0' indicates that the periodic activation of loads is deactivated, whereas '1' indicates it is activated.

## P11: MEASUREMENT UNIT

This parameter permits to select the measurement unit required, in °C or °F.

AFTER SELECTING PARAMETER P11 PRESS  
THE '↵' KEY.



THE DISPLAY SHOWS 'UNIT'.



PRESS '↵'. THE DISPLAY  
SHOWS 'UNIT' FLASHING.



SET THE MEASUREMENT UNIT REQUIRED BY  
PRESSING ARROWS '▲' or '▼'.



PRESS THE '↵' KEY TO CONFIRM THE  
PROGRAMMING OR PRESS THE 'esc' KEY TO CANCEL  
THE CHANGES.

Measurement unit		
Data	Regulation range	Default
UNIT	°C .. °F	°C



### WARNING

Changing the measurement unit from °C to °F, or vice versa, will entail the reset of the "default" data, that is the loss of all the personal data included and stored in the power unit, such as thermal parameters, hydraulic scheme, counters, password, and any other data stored in the internal storage of the power unit itself.

The default data reset could be exploited, for example, if the installer wanted to set the factory data again without however changing every single parameter.

If the measurement unit is changed, the power unit will be reset in scheme no.1 and the message 'RST data' will appear on the display for approx. 6 seconds to indicate that all data have been reset to the default values.

## P12: MINIMUM TEMPERATURE LIMITATION

The parameter 'Minimum Temperature Limitation' on collector is used to manage the Minimum Temperature Thermostat used for activation of the collector pumps.

This thermostat stops the pumps operation whenever on the relevant panel is measured a temperature lower than the one set in this parameter.

The function 'Minimum Temperature Limitation' is not active when in ABC operation or in case the pumps activation is caused by the intervention of Recooling or similar functions.

AFTER SELECTING PARAMETER P12 PRESS  
THE '←' KEY.

WITH ARROWS '▲' OR '▼', YOU CAN CYCLE AMONG  
THE FOLLOWING THERMAL DATA FOR REGULATION:

- Setting of the collector minimum temperature 'MTC'
- Enabling/Disabling of the  
minimum temperature limitation 'MTEN'

PRESS THE '←' KEY TO MODIFY THE THERMAL DATA  
SELECTED; THE DATA WILL START FLASHING.

USE THE '▲' OR '▼', ARROWS TO SET THE  
DESIRED NUMERIC VALUE.

PRESS THE '←' KEY TO CONFIRM THE  
PROGRAMMING OR PRESS THE 'esc' KEY TO CANCEL  
THE CHANGES.

### Adjustment of collector minimum temperature

Data	Regulation range	Default
MTC	10.0°C .. 90.0°C	10.0 °C

Enabling/disabling the collector minimum temperature		
Data	Regulation range	Default
MTEN	0 .. 1	0

**Note:** with ' 0 ' the limitation of minimum temperature on collector is disabled, while with ' 1 ' it is enabled.

### P13: SETTING PWM / PWM W OUTPUTS

Using this parameter you can enter the set up to control the pumps connected to the outputs 'PWM E' and ' PWM W ' of the unit.

AFTER SELECTING PARAMETER P13 PRESS THE ' ← ' KEY.



WITH THE ARROWS ' ▲ ' OR ' ▼ ', IS POSSIBLE TO SCROLL CYCLICALLY THROUGH THE FOLLOWING HEATING SETTINGS:

- Type of connected pump settings ' PUMP '
- Logic functioning setting ' MODO '
- Pump speed control Time EAST ' TMRE '

*The following 'TMRW' parameter is only visible if you have selected a hydraulic diagram with two EAST/ WESTcollectors:*

- WEST pump speed control time ' TMRW '

*The following 'TFTE' parameter is only visible if the parameter P13 = > MODE is set to 'MFT':*

- Check set pointtemperature (EASTcoll.) ' TFTE '

The following 'TFTW' parameter is only visible if the parameter P13 = > MODE is set to 'MFT' and if a hydraulic diagram with two EAST / WEST collectors has been selected:

- Check set point temperature (WESTcoll.) 'TFTW'

Below you are shown the parameters whose default value changes depending on whether the 'PUMP' parameter is set to 'REV' (PWM1) or 'NOR' (PWM2).

The following parameters are related to the EAST collector pump:

- % PWM signal to turn off the pump 'EOFF'

- % PWM signal to turn on the pump and run it at minimum speed 'EON'

- % PWM signal to control the pump at full speed 'EMAX'

- The pump's flow with the PWM %ON 'EFMN'

The following parameters are related to the WEST collector pump and are visible only when a hydraulic diagram is selected with two EAST / WEST collectors:

- % PWM signal to turn off the pump 'WOFF'

- % PWM signal to turn on the pump and run it at minimum speed 'WON'

- % PWM signal to control the pump at full speed 'WMAX'

- The pump's flow with the PWM %ON 'WFMN'



PRESS THE '←' KEY TO MODIFY THE THERMAL DATA SELECTED; THE DATA WILL START FLASHING.



USE THE '▲' OR '▼', ARROWS TO SET THE DESIRED NUMERIC VALUE.



PRESS THE '←' KEY TO CONFIRM THE PROGRAMMING OR PRESS THE 'esc' KEY TO CANCEL THE CHANGES.

In the following the regulation ranges allowed for each parameter are listed.

Setting up the connected pump type		
Data	Regulation range	Default
PUMP	REV .. NOR	NOR

## Settings details

### REV setting

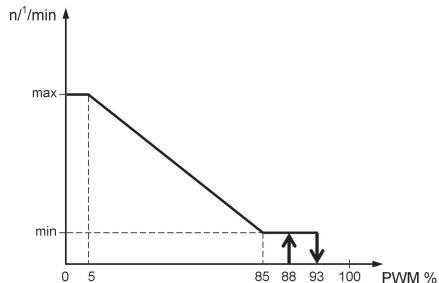

The pumps connected at the outputs PWM E and/or PWM W operate according to the "PWM1" standard, through the heating logic, also known as "inverted".

When the PWM signal is at the minimum value (0%) the pump runs at full speed, while with the PWM signal generated at the maximum value (100%) the pump runs at the

minimum speed. Obviously, the pump will operate at all the intermediate speeds according to the modulation of the PWM signal between 0% and 100%.

### NOR setting

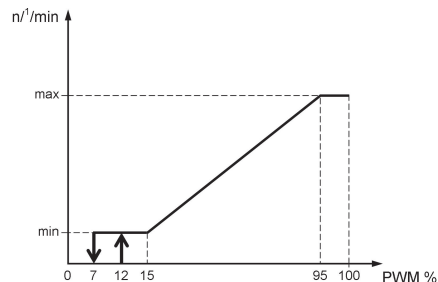

The pumps connected at the outputs PWM E and/or PWM E operate according to the "PWM2" standard, through the solar logic, also known as "normal".

When the PWM signal is at the minimum value (0%), the pump runs at minimum speed, while with the PWM signal generated at the maximum value (100%), the pump runs at full speed.

Obviously, the pump will operate in all the intermediate speeds according to the modulation of the PWM signal between 0% and 100%.



Setting the operating logic		
Data	Regulation range	Default
MODO	MdT .. MFT	MdT

## Details of the settings

### Setting MdT (differential mode)

*Note: The detail of the settings refers to the pump connected with the 'PWM E' output. The same considerations also apply to the pump connected to the 'PWM W' output considering the parameters related to the WEST collector.*

The setting of the speed of the pump connected on the 'PWM E' output is made through the comparison of the measured  $\Delta T$  with the previously set  $\Delta T$ .

When the temperature differential  $\Delta T$  measured between the collector and tank probes is higher than the set temperature differential  $\Delta T$ , set for the solar control, the speed is increased to reach the maximum just after the control time 'TMRE' has passed.

When the differential temperature  $\Delta T$  measured between the reference probes is lower than the set temperature difference  $\Delta T$  for the solar control, then the speed is reduced until it reaches the minimum just after the control time 'TMRE' has

passed.

When the control unit decreases the speed of the pump until it reaches the minimum level 'EON' and the  $\Delta T$  between the sensors is still lower than the set  $\Delta T$ , then the pump switches off, taking itself at the level 'EOFF'.

### Setting MFT (fixed temperature mode)

*Note: The detail of the settings examines the pump connected with the 'PWM E' output. The same considerations also apply to the pump connected to the 'PWM W' output considering the parameters related to the WEST collector.*

The unit adjusts the pump speed according to the temperature value 'TFTE'.

When the temperature at the reference EAST probe collector is higher than the set value 'TFTE', then the speed increases to the maximum just after the control time 'TMRE' has passed.

When the temperature measured by the collector sensor is lower than the set value, then the speed decreases to the minimum value just after the control time 'TMRE' has passed.

Collector pump speed control time EAST		
Data	Regulation range	Default
TMRW	1 .. 15 minuti	4 minuti

Collector pump speed control time WEST <sup>1</sup>		
Data	Regulation range	Default
TMRW	1 .. 15 minuti	4 minuti

*Note:*

*1: The 'TMRW' parameter is only visible if you have selected a hydraulic diagram with two EAST / WEST collectors.*

### Detail of the parameter TMRE - TMRW

It allows you to set the maximum time needed for the pump to switch from minimum to maximum speed and vice versa in order to avoid sudden changes or oscillations of the system.

Fixed point temperature control (EAST Collector)		
Data	Regulation range	Default
TFTE	0 °C .. 90 °C	60 °C

Fixed point temperature control (WEST Collector <sup>1</sup> )		
Data	Regulation range	Default
TFTW	0 °C .. 90 °C	60 °C

*Note:*

*These parameters are active only if the MFT option has been selected in parameter 'MODE'.*

*1: The 'TFTW' parameter is only visible if you have selected a hydraulic diagram with two EAST / WEST collectors.*

*Below are shown the parameters related to the PWM E output, referring to the EAST collector's pump and the default values with the 'PUMP' parameter set to 'REV'.*

<b>Signal level in %PWM for pump turn off</b>		
Data	Regulation range	Default
E0FF	E0N .. 100%	100%

<b>Signal level in %PWM for pump minimum speed</b>		
Data	Regulation range	Default
E0N	E0M0X .. E0FF	90%

<b>Signal level in % PWM for pump maximum speed</b>		
Data	Regulation range	Default
E0M0X	0% .. 50%	0%

<b>Minimum pump flow in% corresponding to level E0N<sup>1</sup></b>		
Data	Regulation range	Default
E0FMN	0% .. 100%	30%

*Below are displayed the parameters for the PWM W output, referring to the WEST collector pump and the default values with the parameter 'PUMP' set to 'REV'. These parameters are only visible when a hydraulic diagram has been selected with two collectors (EAST/ WEST).*

<b>Signal level in %PWM for pump turn off</b>		
Data	Regulation range	Default
W0FF	W0N .. 100%	100%

<b>Signal level in %PWM for pump minimum speed</b>		
Data	Regulation range	Default
W0N	W0M0X .. W0FF	90%

<b>Signal level in %PWM for pump maximum speed</b>		
Data	Regulation range	Default
W0M0X	0% .. 50%	0%

<b>Minimum pump flow in% corresponding to level W0N<sup>1</sup></b>		
Data	Regulation range	Default
W0FMN	0% .. 100%	30%

Below are shown the parameters related to the PWM output, referring to the EST collector pump and the default values with the parameter 'PUMP' set to 'NOR'.

<b>Signal level in %PWM for pump turn off</b>		
Data	Regulation range	Default
E0FF	0% .. E0N	0%

<b>Signal level in %PWM for pump minimum speed</b>		
Data	Regulation range	Default
E0N	E0FF .. EMAX	10%

<b>Signal level in %PWM for pump maximum speed</b>		
Data	Regulation range	Default
EMAX	50% .. 100%	100%

<b>Minimum pump flow in % corresponding to level E0N <sup>1</sup></b>		
Data	Regulation range	Default
EFMN	0% .. 100%	30%

Below you are shown the parameters for the PWM W output, referring to the WEST collector pump and the default values with the parameter 'PUMP' set to 'NOR'. These parameters are only visible when a hydraulic diagram with two collectors (EAST/WEST) has been selected.

<b>Signal level in %PWM for pump turn off</b>		
Data	Regulation range	Default
W0FF	0% .. W0N	0%

<b>Signal level in %PWM for pump minimum speed</b>		
Data	Regulation range	Default
W0N	W0FF .. WMAX	10%

<b>Signal level in %PWM for pump maximum speed</b>		
Data	Regulation range	Default
WMAX	50% .. 100%	100%

<b>Minimum pump flow in % corresponding to level W0N <sup>1</sup></b>		
Data	Regulation range	Default
WFMN	0% .. 100%	30%

*Note.*

*1: pump flow rate when controlled with EON or with WON: this value is typical for the actual pump. This parameter has no effect on the regulation, it affects the display only.*



### **WARNING**

The activation of the collector's pump (both the one connected to the PWM E output and the one connected to the PWM W output) may not take place simultaneously with the display, when the flashing pump symbol pops up.

Actually the pump may be turned on with some delay, in relation to the symbol on the display. Since each pump has a preset OFF signal, in order to be activated, the output signal must reach the OFF level set on the pump.

## **P14: RESET COLLECTOR TEMPERATURE**

With this parameter you can set the temperature value ('T\_SE' - 'T\_SW') for the reset of the collector pump in case the safe temperature TS\_2 is reached, in order to avoid thermal shocks and air bubbles in the system.

The collector pump will be restarted automatically only when the temperature of the collector, measured by the probe S\_1 for EAST collector or S\_4 for the WEST collector, falls below the reset temperature, respectively, T\_SE or T\_SW.

AFTER SELECTING PARAMETER P14 PRESS  
THE '←' KEY.



WITH ARROWS '▲' OR '▼', YOU CAN CYCLE AMONG  
THE FOLLOWING DATA FOR REGULATION:

- Collector reset temperature EAST                    ' T\_SE '
- Collector reset temperature WEST                    ' T\_SW '



PRESS THE '←' KEY TO MODIFY THE DATA  
SELECTED; THE DATA WILL START FLASHING.



USE THE '▲' OR '▼', ARROWS TO SET THE  
DESIRED NUMERIC VALUE.



PRESS THE '←' KEY TO CONFIRM THE  
PROGRAMMING OR PRESS THE 'esc' KEY TO CANCEL  
THE CHANGES.

#### Collector reset temperature EST

Data	Regulation range	Default
T_SE	OFF / 60 °C .. 180 °C	OFF

#### Collector reset temperature OVEST <sup>1</sup>

Data	Regulation range	Default
T_SW	OFF / 60 °C .. 180 °C	OFF

**Note:**

1: The 'T\_SW' parameter is only visible if you have selected a hydraulic diagram with two EAST /WEST collectors.

## P15: VACUUM TUBES

In some solar systems, for example when vacuum tubes are installed, the collector temperature measurement could be slow, because of its non optimal position.

By enabling the function you can choose between two different operating programs:

**P\_1** where VTC function is enabled and Boiler safety thermostats are prioritized.

**P\_0** where VTC function is enabled and both Boiler and collector pump safety thermostats are disabled.

**By enabling the VTC, the following collector pump control is started:**

*Note: The detail of the settings examines the pump connected with the 'PWM E' output. The same considerations also apply to the pump connected to the 'PWM W' output considering the parameters related to the WEST collector.*

If the collector sensor temperature increases by the amount set in the subparameter 'IN\_E' within one minute, then the collector pump will be operated for the time set in the subparameter 'TM\_E'.

After the activation of the pump for the time set in the subparameter 'TM\_E', the function will be off for 5 minutes.

AFTER SELECTING PARAMETER P15 PRESS  
THE '←' KEY.



WITH ARROWS '▲' OR '▼', YOU CAN CYCLE AMONG  
THE FOLLOWING DATA FOR REGULATION:

- Enable parameter for EAST collector 'EN\_E'
- Increase temperature for EAST collector 'IN\_E'
- EAST Collector's pump activation lapse 'TM\_E'
- Enable parameter for WEST1 collector 'EN\_W'
- Increase temperature for WEST1 collector 'IN\_W'
- WEST1 collector's pump activation lapse 'TM\_W'



PRESS THE '↵' KEY TO MODIFY THE DATA  
SELECTED; THE DATA WILL START FLASHING.



USE THE '▲' OR '▼', ARROWS TO SET THE DESIRED NUMERIC VALUE.



PRESS THE '←' KEY TO CONFIRM THE PROGRAMMING OR PRESS THE 'esc' KEY TO CANCEL THE CHANGES.

EAST Collector vacuum tubes		
Data	Regulation range	Default
EN_E	OFF / P_1 / P_0	OFF
IN_E	1 °C/min. .. 10 °C/min.	3°C/min.
TM_E	2 sec. .. 30 sec.	5 sec.

WEST Collector vacuum tubes <sup>1</sup>		
Data	Regulation range	Default
EN_W	OFF / P_1 / P_0	OFF
IN_W	1 °C/min. .. 10 °C/min.	3°C/min.
TM_W	2 sec. .. 30 sec.	5 sec.



#### WARNING

By enabling the parameter 'EN\_E' or 'EN\_W' in 'P\_0', any safety of the tank are turned off, therefore temperatures in the boiler may exceed the set safety thresholds.

*Nota:*

*1: The 'EN\_W', 'IN\_W' and 'TM\_W' parameter is only visible if you have selected a hydraulic diagram with two EAST/WEST collectors.*



## P16: ANTI-LEGIONELLA

Through this parameter you can enable or disable the Anti-legionella function.

The anti-Legionella (function activated by default) consists of a boiler's water heating cycle at 65°C every 30 days for 5 minutes (in order to carry out thermal disinfection action against the related bacteria) only in case the water in the tank has not been driven at least once at 65°C for 5 minutes without interruptions.

The 30-day counter is reset whenever the water temperature in the boiler reaches 65°C at least for 5 minutes.

If the water, during the heating cycle in the boiler, does not reach 65°C for 5 minutes within one hour, the control unit emits an acoustic signal and the display shows, on the hydraulic diagram, the icon of a flashing boiler. In this alarm situation, the control unit forces the water heating in the boiler and if that succeeds automatically resets the alarm. Otherwise, after entering the parameter P16 "LEG" select the sub-parameter "RS L"; the control unit exits from the alarm condition resetting the 30-day counter.

The Anti-Legionella function can be enabled only for hydraulic schemes which provide additional heating: diagrams 2 - 7 - 10 - 12 - 16 - 18 - 19 (selectable in the installer parameter P1).

AFTER SELECTING PARAMETER P16 PRESS  
THE ' ← ' KEY.



WITH THE ARROWS ' ▲ ' OR ' ▼ ', YOU CAN SCROLL  
CYCLICALLY THROUGH THE FOLLOWING SETTING  
PARAMETERS:

- Enabling the anti-legionella function ' EN L '
- Alarm reset ' RS L '



PRESS THE ' ← ' KEY TO ENTER SELECTED  
PARAMETER SETTINGS;  
THE PARAMETER STARTS TO BLINK.



WITH THE ARROWS ' ▲ ' OR ' ▼ ', ENABLE / DISABLE  
THE SELECTED PARAMETER.



PRESS THE '←' KEY TO CONFIRM THE PROGRAMMING OR PRESS THE 'esc' KEY TO CANCEL THE CHANGES.

The setting ranges for each individual data are listed below.

Enabling the anti-legionella function		
Data	Regulation range	Default
EN L	0 .. 1	1

**Note:** with '0', the function is disabled, while with '1' the function is activated.

Alarm Reset / Reset of the 30-days counter.		
Data	Regulation range	Default
RS L	0 .. 1	0

**Note:** Selecting '1' the control unit exits from the alarm mode, resetting the 30 days' counter.



#### WARNING

- When the Anti-Legionella function is enabled, both maximum TM and safety TS temperatures, if they are lower, are automatically set to the following values:  
TM:- TLEG + 5.0°C  
TS:- TLEG + 10°C
- The temperature value of anti-Legionella is fixed to 65°C, therefore not adjustable.
- The differential value is fixed to 2°C, therefore not adjustable.

## FUNCTIONS ACCESSIBLE TO THE USER

The functions accessible to the user are limited and do not allow setting those data influencing the installation management. The only operations allowed to the user are the following:

### Turning on / Turning off the control unit

### Activation/Deactivation of the control unit's ABC function.

#### User menu

PRESS THE '  ' KEY TO ACCESS ' USER PARAMETERS '.

THE FIRST ' USER PARAMETER ' IS SHOWN.

USING THE ' ▲ ' or ' ▼ ' ARROWS IT IS POSSIBLE TO SCROLL CYCLICALLY THROUGH THE USER PARAMETERS:

U1: SHOWS MAXIMUM TEMPERATURES  
U2: ENABLES / DISABLES ANTIFROST

PRESS THE ' ← ' KEY TO SELECT THE DESIRED PARAMETER.

SET THE DESIRED VALUE FOR EVERY SINGLE PARAMETER AS EXPLAINED BELOW.

PRESS THE ' esc ' KEY TO RETURN TO THE USER PARAMETERS SELECTION MENU.

WAIT 20 SECONDS OR PRESS THE ' esc ' KEY TO QUIT THE USER MODE.



#### WARNING!

In the ' USER PARAMETERS ' mode all the outputs are disabled.

**Displaying the Maximum Temperatures recorded**  
Parameter ' TMAX U1 ' allows to display the maximum temperature recorded in the system for each probe TM-.

PRESS THE '↵' KEY  
TO VIEW THE TEMPERATURE.



USING THE '▲' or '▼' ARROWS IT IS POSSIBLE  
TO SCROLL CYCLICALLY THROUGH THE RECORDED  
TEMPERATURES:

TM1 → TM2 → TM3 → TM4



PRESS THE '↵' KEY. THE DISPLAY SHOWS FLASHING  
THE NUMBER OF THE PROBE.  
PRESSING THE 'esc' KEY RETURNS TO SHOWING THE  
USER PARAMETERS.



PRESSING '↵' RESETS THE TEMPERATURE  
RECORDED TO THAT POINT;  
PRESSING 'esc' RETURNS TO SHOWING THE  
MEMORIZED TEMPERATURE.



PRESS THE 'esc' KEY TO QUIT THE MAXIMUM  
TEMPERATURE DISPLAY MODE.

### Antifrost Activation

The 'AFR U2' parameter (anti-frost) enables or disables the antifrost function. The management of the antifrost data is performed through the user parameters.

PRESS THE '↵' KEY;  
THE DISPLAY SHOWS 'AFR' FLASHING.





USING THE '▲' or '▼' ARROWS IT IS POSSIBLE TO  
ENABLE OR DISABLE THE ANTIFROST:  
**0: DISABLED**  
**1: ENABLED (THE DISPLAY SHOWS ❄)**



PRESS THE '↵' KEY TO CONFIRM THE  
PROGRAMMING OR PRESS THE 'esc' KEY TO QUIT  
USER PARAMETERS.

## TROUBLESHOOTING

ANOMALY	POSSIBLE CAUSE										
<p>During normal operation the control unit displays the symbol  and emits an acoustic signal characterized by a series of 'beeps'. The probe originating the problem is flashing on the display.</p>	<p>The control unit has revealed an anomaly on the probe. The display shows the number of the damaged probe and the type of anomaly present.</p> <table border="0"> <tr> <td>Open circuit on probe input (<math>R = \infty</math>).</td> <td>Short circuit on probe input (<math>R \approx 0</math>).</td> </tr> <tr> <td>COL OPEn</td> <td>COL ShrT</td> </tr> <tr> <td>S_2 OPEn</td> <td>S_2 ShrT</td> </tr> <tr> <td>S_3 OPEn</td> <td>S_3 ShrT</td> </tr> <tr> <td>S_4 OPEn</td> <td>S_4 ShrT</td> </tr> </table>	Open circuit on probe input ( $R = \infty$ ).	Short circuit on probe input ( $R \approx 0$ ).	COL OPEn	COL ShrT	S_2 OPEn	S_2 ShrT	S_3 OPEn	S_3 ShrT	S_4 OPEn	S_4 ShrT
Open circuit on probe input ( $R = \infty$ ).	Short circuit on probe input ( $R \approx 0$ ).										
COL OPEn	COL ShrT										
S_2 OPEn	S_2 ShrT										
S_3 OPEn	S_3 ShrT										
S_4 OPEn	S_4 ShrT										
<p>The display shows the icon  and the control unit emits an acoustic signal characterized by a series of 'beeps'.</p>	<p>One or more probes are measuring a temperature higher than the relevant programmed safety temperature.</p>										
<p>In the selection of the installation to be realized (installer parameter P1) one or more probes flashing.</p>	<p>The probe is miswired or damaged.</p>										

## WARRANTY

In the view of a constant development of their products, the manufacturer reserves the right for changing technical data and features without prior notice. The consumer is guaranteed against any lack of conformity according to the European Directive 2019/771 as well as to the manufacturer's document about the warranty policy. The full text of warranty is available on request from the seller.

**NOTES:**



WIST03290EAN 040405 181122